



PAT

PAT

LOAD MOMENT INDICATOR

DS 350G/GW

LMI for Hydraulic Boom Cranes

www.patamerica.com

PAT America, Inc.

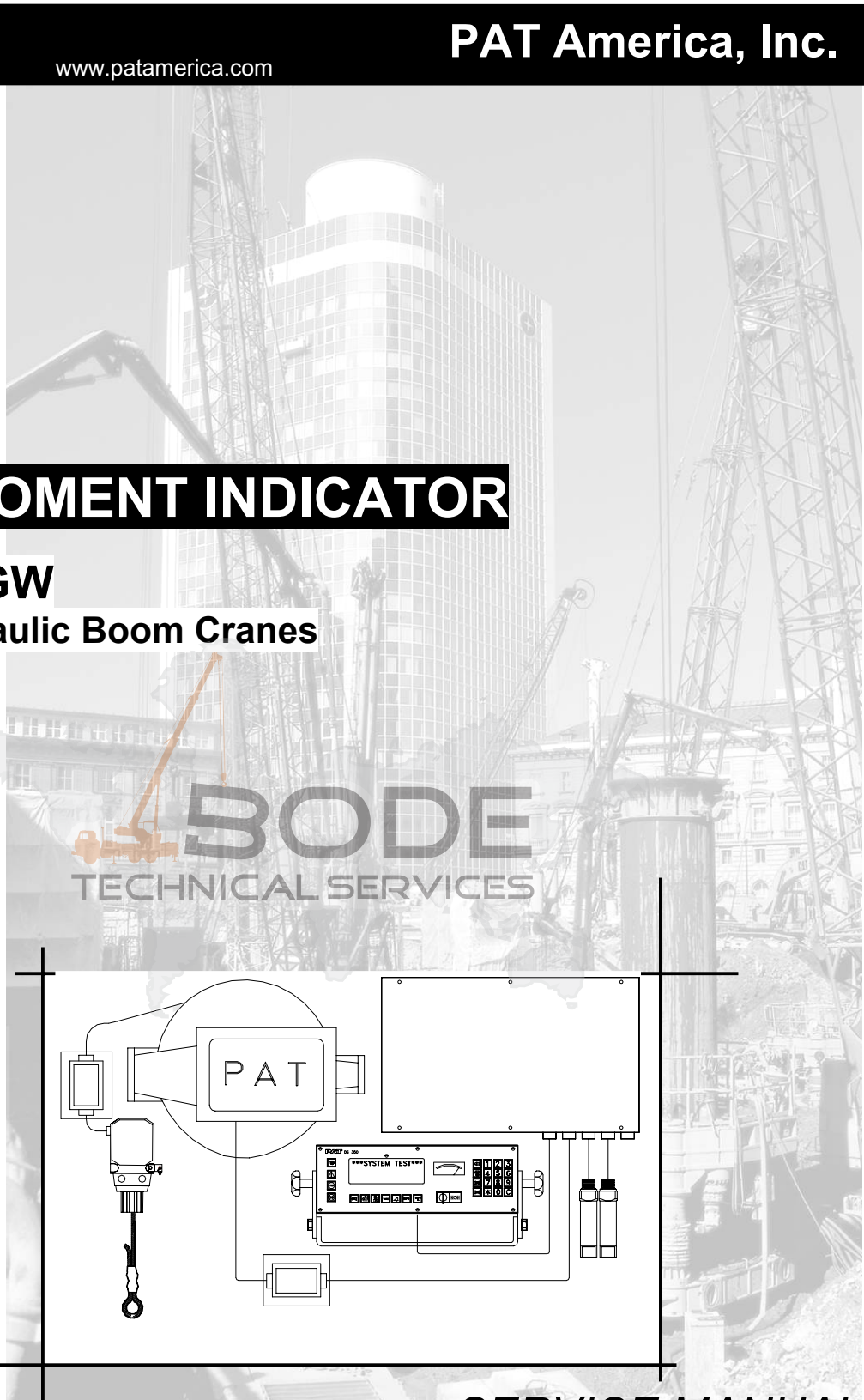

BODE
TECHNICAL SERVICES

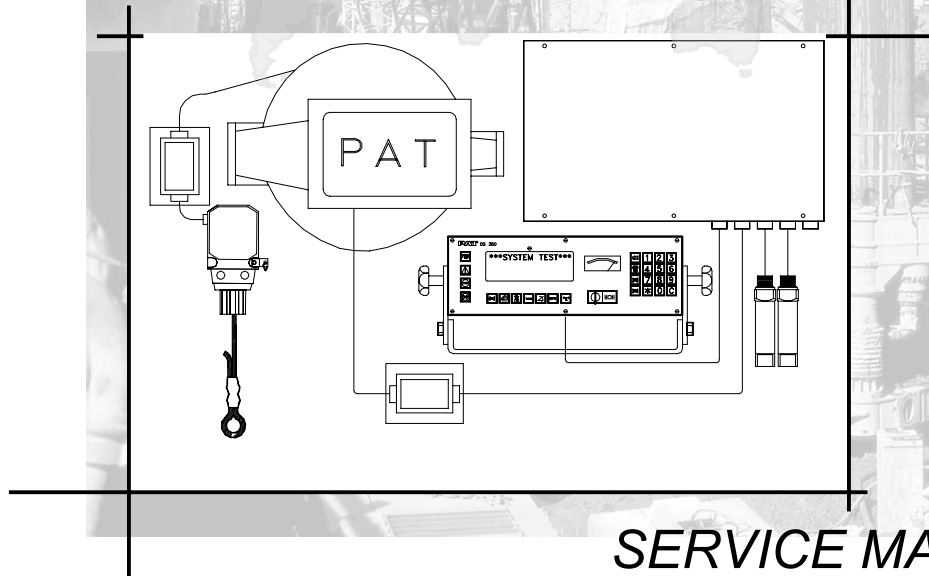

SERVICE MANUAL

P/N 031-300-190-046, Rev. B, 04/18/01

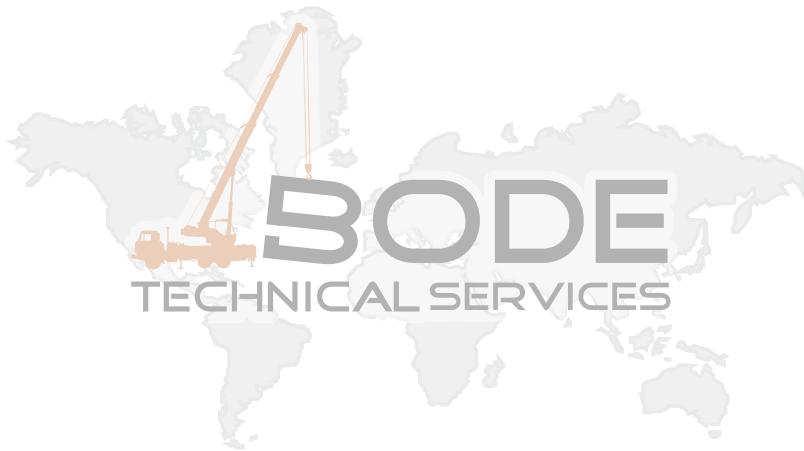

NOTICE

The information in this document is subject to change without notice.

PAT makes no warranty of any kind with regard to this material, including, but not limited to, the implied warranties of merchantability and fitness for a particular purpose.

PAT shall not be liable for errors contained herein or for incidental or consequential damages in connection with the furnishing, performance or use of this manual.

This document contains proprietary information which is protected by copyright. All rights are reserved. No part of this document may be photocopied, reproduced, or translated to another language without prior consent of PAT.

MANUAL REVISIONS

REV	DATE	NAME	DESCRIPTION
-	7/27/98	CSH	CREATED TROUBLESHOOTING MANUAL
A	8/24/00	CSH	Text changes throughout manual
B	04/18/01	CSH	Text, error codes, and reference changes

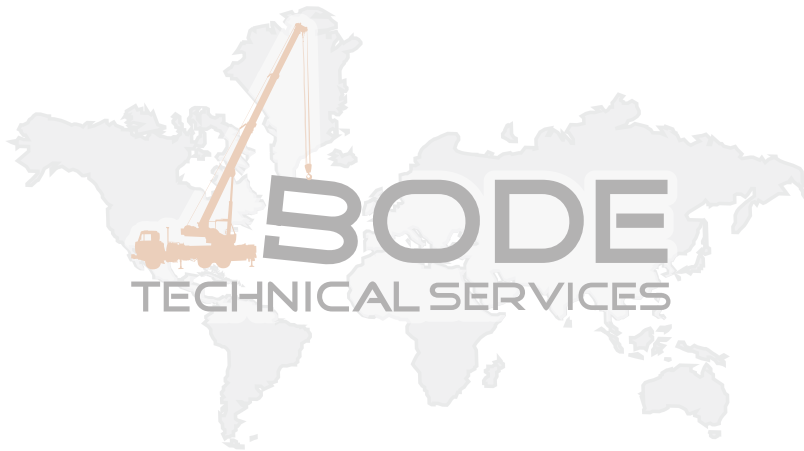

TABLE OF CONTENTS

SECTION 1. MECHANICAL DESCRIPTION OF THE SYSTEM 1

 1.0 MECHANICAL DESCRIPTION OF THE COMPONENTS..... 1

 2.0 MECHANICAL AND ELECTRICAL DESCRIPTION OF THE CENTRAL UNIT... 2

 3.0 BASIC ADJUSTMENT OF THE HARDWARE 3

SECTION 2. DEFINITIONS 4

SECTION 3. DRAWINGS 5

 DRAWING 1. Cable Reel 068-208-060-013 LWG208 Spare Parts List..... 5

 DRAWING 2. Cable Reel LWG208 6

 DRAWING 3. Length Sensor Assembly 006-710-006-002..... 7

 DRAWING 4. Angle Sensor WG103 Assembly 064-103-060-002 8

 DRAWING 5. Angle Sensor WG203 Adjustment 006-420-306-001 9

 DRAWING 6. Anti-Two Block Switch 031-002-060-011 10

 DRAWING 7. Pressure Transducer 044-213-060-001 11

 DRAWING 8. Pressure Transducer Cable Assembly..... 11

 DRAWING 9. Jumper Cable Assembly for Extension 031-300-103-541 12

 DRAWING 10. Eprom replacement in Central Unit 13

 DRAWING 12. Central Unit Electrical Diagram 15

 DRAWING 13. Cable Reel Electrical Diagram 16

 DRAWING 14. A-Frame or Swingaway Extension Electrical Diagram 17

 DRAWING 15. Offset Swingaway Extension Electrical Diagram..... 18

 DRAWING 16. Tele Swingaway Extension Electrical Diagram 19

 DRAWING 17. Electrical Diagram - Console to Central Unit..... 20

 DRAWING 18. Electrical Diagram - Cable Reel to Central Unit 21

 DRAWING 19. Electrical Diagram - Pressure Transducer to Central Unit..... 23

SECTION 4. THEORY 25

 THEORY 1. Anti-Two Block & Shutoff Circuit..... 25

 THEORY 2. Length Measuring Channel #1..... 25

 THEORY 3. Piston Side Pressure Measuring Channel #2 26

 THEORY 4. Rod Side Pressure Measuring Channel #3..... 27

 THEORY 5. Force Transducer Measuring Channel #4 27

 THEORY 6. Main Boom Angle Measuring Channel #5 29

 THEORY 7. Jib Angle Measuring Channel #6..... 29

 THEORY 8. BASIC ADJUSTMENT AND VOLTAGE CHECKS 30

5. TROUBLESHOOTING FLOW CHARTS..... 32

 1. GENERAL FLOWCHART..... 32

 4. NO DISPLAY 35

 5. ANTI TWO BLOCK PROBLEM 37

 6. LENGTH READING PROBLEM 40

 7. LOAD READING PROBLEM..... 43

 8 BAD DATA TRANSFER BETWEEN CONSOLE & CENTRAL UNIT 46

 9. INTERFERENCE PROBLEM 48

 10. LIGHTBAR MALFUNCTION..... 49

6. ERROR CODE DISPLAY..... 51

REFERENCE GUIDE..... 58

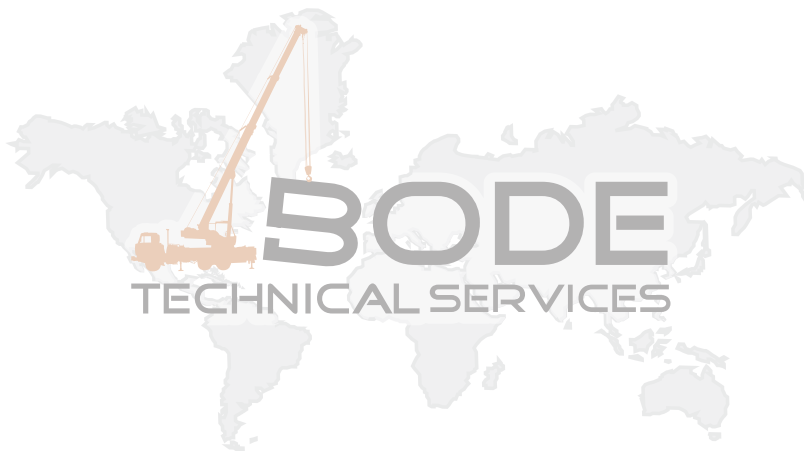

SECTION 1. MECHANICAL DESCRIPTION OF THE SYSTEM

1.0 MECHANICAL DESCRIPTION OF THE COMPONENTS

- 1.1 Pressure Transducer:** The pressure transducer transforms hydraulic pressure into an electric analogue voltage signal. Two pressure transducers are connected, one to the rod side and one to the piston side of the lift cylinder. The pressure transducer is connected to the central unit with a four conductor, double - shielded cable.

The power supply voltage is $\pm 5V$.

The output signal is 0.00V under 0 pressure to -1.00V at max. pressure (4410psi)

- 1.2 The Length-Angle Transducer:** The length-angle sensor (LWG) is a combination of two transducers in one box, fitted at the base section of the boom. It measures the length and the angle of the boom.

A reeling drum drives a potentiometer, which is the length transducer. Part of the length transducer circuit is the length cable on the drum, which is a two-conductor cable (screen and live). It is connected to the anti-two-block switch at the boom head and to a slip ring body in the LWG. The angle transducer is fitted in a small box filled with oil. A pendulum drives the axle of the angle potentiometer.

The power supply voltage for both is -5.00V

The output signal for the length transducer is: -0.500V up to -4.500V

The output signal for the angle transducer is: -1.875V up to -3.125V

- 1.3 Anti-Two-Block Switch:** The anti-two-block switch monitors the load block and it's relationship with the head of the boom. In working condition the switch is closed. When the hook block strikes the weight the circuit opens, disengaging a relay output to the lock out solenoid valves, where applicable. To check the cable for damage, (short circuit to ground) there is a 4.7k resistor between ground and the contact of the switch, to give a signal back to the central unit. The weight at the anti-two-block switch keeps the switch closed until the hook block strikes it.

- 1.4 Console:** The console displays all geometrical information such as length and angle of main boom, working radius and head height of the boom. It also displays the actual load and the maximum load permitted by load chart. Furthermore, it has an alarm horn, a warning light for overload, and a pre-warning light. The analog instrument shows a percentage of the total permissible moment. The console has a switch for the operating modes (duty-selection switch for crane configurations) and a switch for the reeving of the hook block. It also has a warning light for anti-two-block conditions and an override switch for overload or anti-block condition. The console also has a toggle switch that engages digital inputs to identify various hoist options.

1.5 Duty Selection Switches (Digital Inputs): The system has to be programmed for the lifting area configuration. The crane is going to be worked in e.g. main boom on outriggers over front, or rear, or over the side for 360 degrees. For this information from the crane, we use micro switches that are installed in the electrical swivel and tells the system the location of the boom. We also use micro switches on the counterweight that informs the system if the counterweight is installed or not where applicable.

2.0 MECHANICAL AND ELECTRICAL DESCRIPTION OF THE CENTRAL UNIT

All the data of the crane are stored inside the central unit in E-Proms. The central unit gets all actual information of the crane. This is computed against the reference data and the crane status continually monitored.

2.1 Description of the Housing: The central unit DS350 has a rugged, waterproof sheet steel housing. It is mounted on the left side of the turntable weldment or on the counterweight. The cables are led into the central unit via strain reliefs and connected with fast-ons. On the housing is mounted an override connected with fast-ons. On the housing is mounted an override switch to override the LMI function. The system is protected by a 2 AMP fuse which is mounted on the lower right side. The output signal is protected by a 10 AMP fuse, which is mounted on the lower mid.

2.2 Description of the Boards: Inside the central unit there is one board. The main board and the terminal board are two separate boards connected by a pair of ribbon cables. Power and are also connected from the terminal board to the main board. The wires from the various components are connected with fast-ons to the terminal board. The main board is the heart of the system. It contains the main computer and the necessary electronics to receive, evaluate, process and direct the continuous data. There are overload and anti-two-block relays mounted on this board that control the lever lockout(s),.

A power supply prepares all the necessary voltages for the transducers and the electronics on the main board.

An analogue input part, which receives and prepares all the signals from the transducers for further processing.

An analogue/digital converter converts all the processed analogue signals into digital ones.

A digital circuit contains the main computer and the ancillary electronics.

2.3 Incoming Signals: The signals from the transducers are connected to the terminal board. The signals of the angle-length transducer are connected to terminal #9 (angle) and terminal #10 (length). The signal on terminal #9 (angle) is between -1.875V (90°) and -3.125V (0°). The signal on terminal #10 (length) is between -0.500V retracted M/B and -4.500V. The signals from the pressure transducers are connected to terminal #16 (rod side) and terminal #21 (piston side). The signals on terminals #16 and #21 are between 0.00V @ 0PSI and -1.00V @ max PSI.

The signal from the force transducer is connected to the terminals #28 and #29. The signal between #29 (negative output) and #28 (positive output) is between 0.00V @ 0 force and +2.500V @ max force.

The inputs for the duty selection switches are the terminals #38, 40, 42 for positive signals, or #37, 39, 41 for negative signals.

The input for the anti-two-block switch is terminal #35.

- 2.4 Outgoing Signal:** The outgoing signal of the terminal board is the signal for lever lockout of terminal #48. In normal working conditions there are 12 volts at this terminal. If there is an overload or anti-two-block condition, the signal becomes 0 volts. Furthermore, all supply voltages for the transducers are going out via the terminal board.

3.0 BASIC ADJUSTMENT OF THE HARDWARE

- 3.1 Length:** Ensure that the length cable tension is correct with fully retracted boom by turning the cable reel 5 to 8 turns counterclockwise. Then remove cover form LWG and adjust counterclockwise the potentiometer to end stop.
- 3.2 Angle:** Set the boom between 0 and 5 degrees and set the inclinometer to the boom angle. Adjust the angle sensor to the same angle as the boom. Check the angle at 20 degrees, 45 degrees, 70 degrees. Angle display should be less than $\pm .5$ degrees of the value of the inclinometer.
- 3.3 Pressure Channel:** Rest the boom and disconnect hydraulic hoses from the pressure transducers. Measure and record the zero-points of both pressure transducers on the terminal board X1-16 (rod) X1-21 (piston). Adjust P4 and P5 on the main board to 500mV at test points MP4 and MP5. Connect hydraulic hoses back to the pressure transducers. Bleed the air.
- 3.4 Duty Selection Switches Digital Inputs):** Check the duty selection switches for correct operation. Check the voltage on digital input terminals.
- 3.5** Check the function of the hoist limit switch (anti-two-block)
- 3.6** Check function of lever lockout.
- 3.7** Measure and record the power supply voltages.

SECTION 2. DEFINITIONS

- 1. BOOM LENGTH** The straight line thru the centerline of boom pivot pin to the centerline of the boom point load hoist sheave pin measured along the longitudinal axis of the boom. (Indicator $\pm 2\%$)
- 2. BOOM ANGLE** The angle between the longitudinal centerline of the boom base section and the horizontal plane. (Indicator 65° to 90° boom angle $+ 0^\circ/2^\circ$; less than 65° boom angle $+ 0^\circ/-3^\circ$)
- 3. RADIUS OF LOAD** The horizontal distance from a vertical projection of the crane's center of rotation, to the center of the vertical hoist line or tackle with rated load applied. (Indicator 100% to 110%)
- 4. RATED LOAD** The load value shown on the applicable load rating chart of the crane for the particular crane configuration, boom length, boom angle, or functions or these variables. For radii outside those shown on the load rating chart, the rated load is to be considered as zero.
- 5. ACTUAL LOAD** The weight of the load being lifted and all additional equipment such as blocks, slings, sensors, etc. Also referred to as working load. (Indicator 100% to 110%)
- 6. CRANE CONFIGURATION** The physical arrangement of the crane as prepared for a particular operation in conformance with the manufacturer's operating instructions and load rating chart.
- 7. TWO-BLOCKING** Contact of the lower load block or hook with the upper load block, boom point, or boom point machinery.
- 8. ANALOG** Electrical signals that vary in proportion to the quantities they represent. (Boom length, angle, and pressure transducer)
- 9. DIGITAL** Electrical signals of an on and off state (two different voltage levels) to represent some quantity of operation. (A2B, area definition switch)

SECTION 3. DRAWINGS

DRAWING 1. Cable Reel 068-208-060-013 LWG208 Spare Parts List

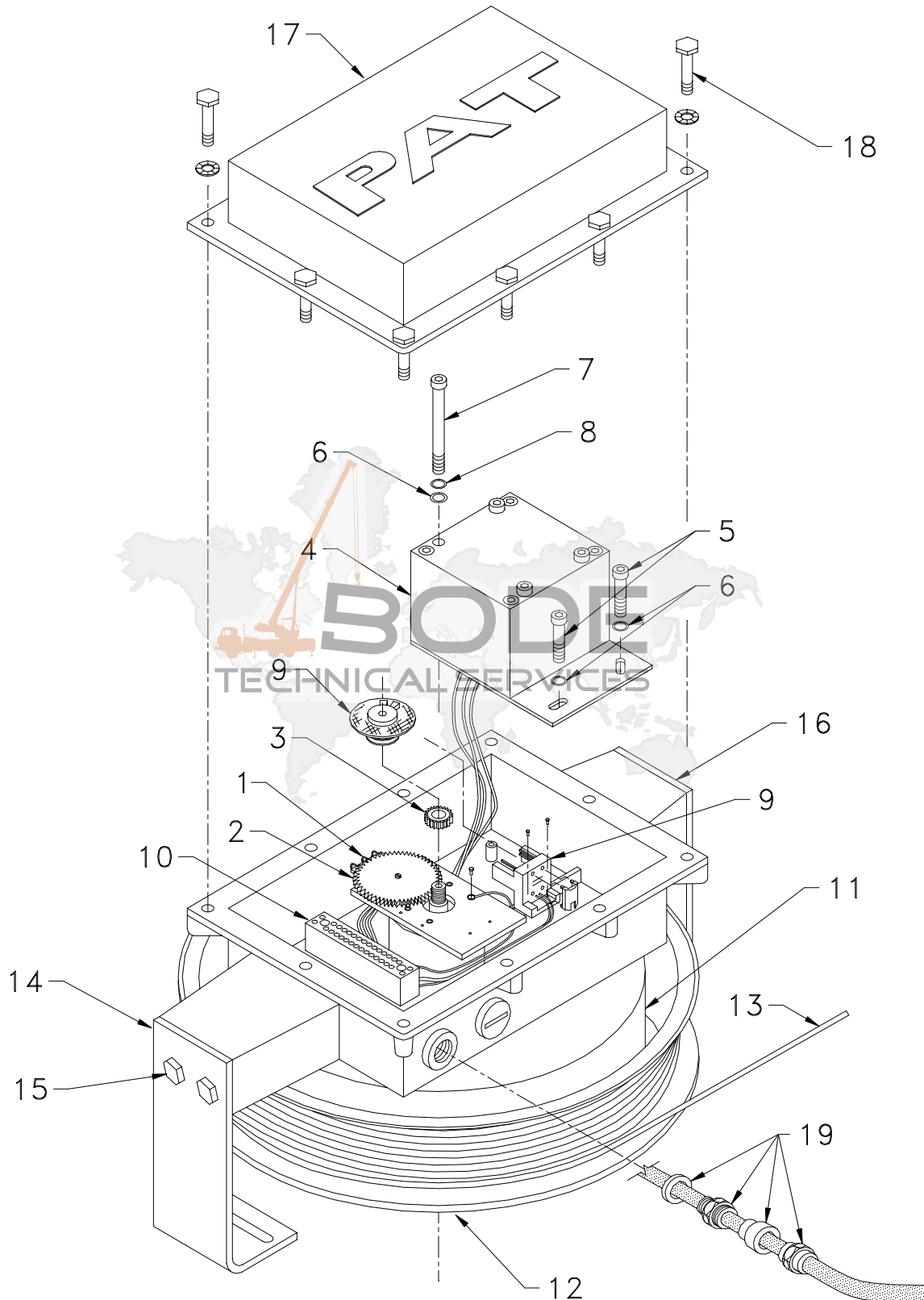

NO.	PART NO.	QTY	DESCRIPTION
01	006-710-006-002	1	SENSOR, LENGTH TRANS. LGE 100 (KT200/LWG208)
02	068-000-110-038	1	SENSOR ACCY, GEAR WHEEL, KT200 CABLE REEL
03	067-000-050-065	1	SENSOR ACCY, GEAR WHEEL, T=50 CENTER SHAFT
04	064-103-060-002	1	SENSOR, ANGLE WG103
05	002-050-206-012	2	SCREW, 6M X 12 SOCKET CAP
06	000-207-010-064	3	WASHER, FLAT 6MM
07	002-050-206-100	1	SCREW, 6M x 100M SOCKET CAP
08	000-208-040-083	1	WASHER, LOCK 6MM
09	068-000-100-064	1	SLIPRING, 2 CONDUCTOR
10	068-000-110-029	1	TERMINAL STRIP
11	068-000-110-010	1	SPRING PACK, W/ HOUSING KT200/LWG208/LWG221
12	068-000-110-011	1	CABLE REEL ACCY, CABLE DRUM,KT 200/ LWG208
13	000-673-020-002	139'	CABLE, LENGTH SENSOR, 1 CORE W/SHEILD (per ft)
14	006-800-005-058	1	BRACKET, MTG. CABLE REEL ARM, ONE SLOT
15	000-205-031-230	4	SCREW, 12mm x 30MM HEX HEAD
16	006-800-005-057	1	BRACKET, MTG. CABLE REEL ARM, TWO SLOTS
17	005-682-000-001	1	COVER, CABLE REEL, KT200
18	068-000-110-031	10	CABLE REEL ACCY, SCREW CABLE REEL COVER
19	021-441-131-013	1	STRAIN RELIEF, PG 13.5, 8-12mm RED+WHITE

DRAWING 2. Cable Reel LWG208

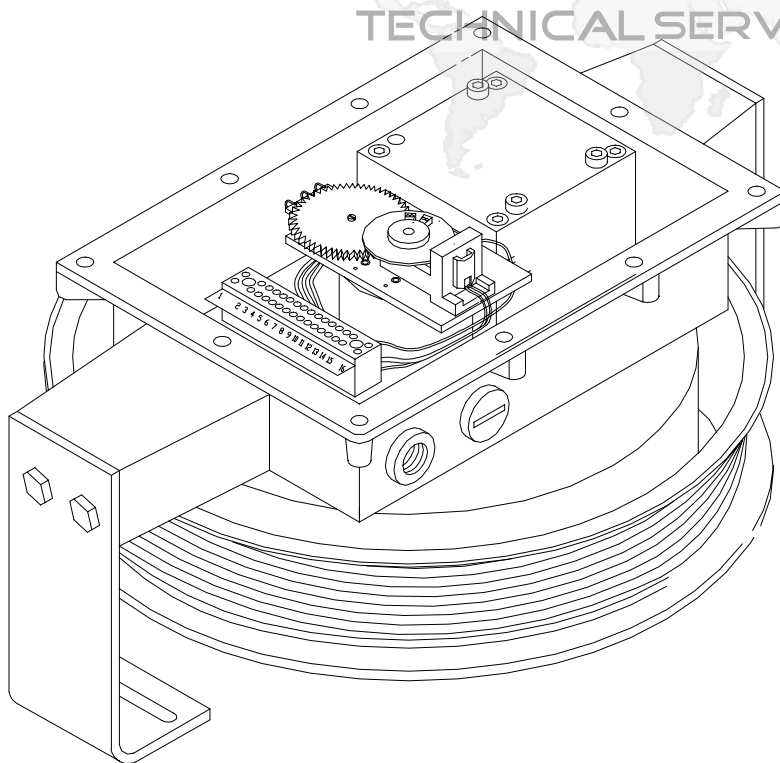

DRAWING 3. Length Sensor Assembly 006-710-006-002

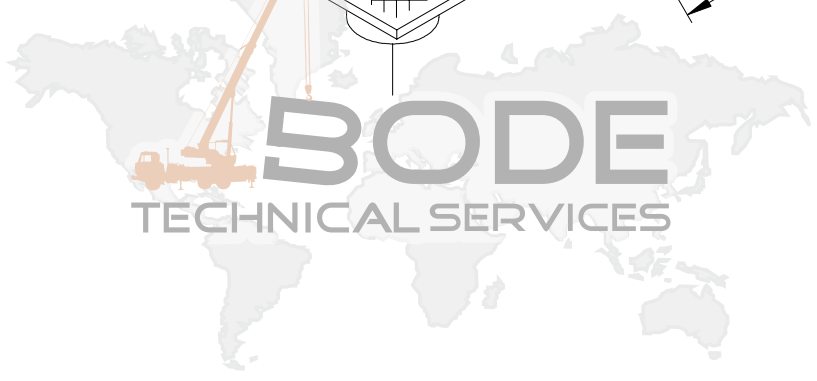
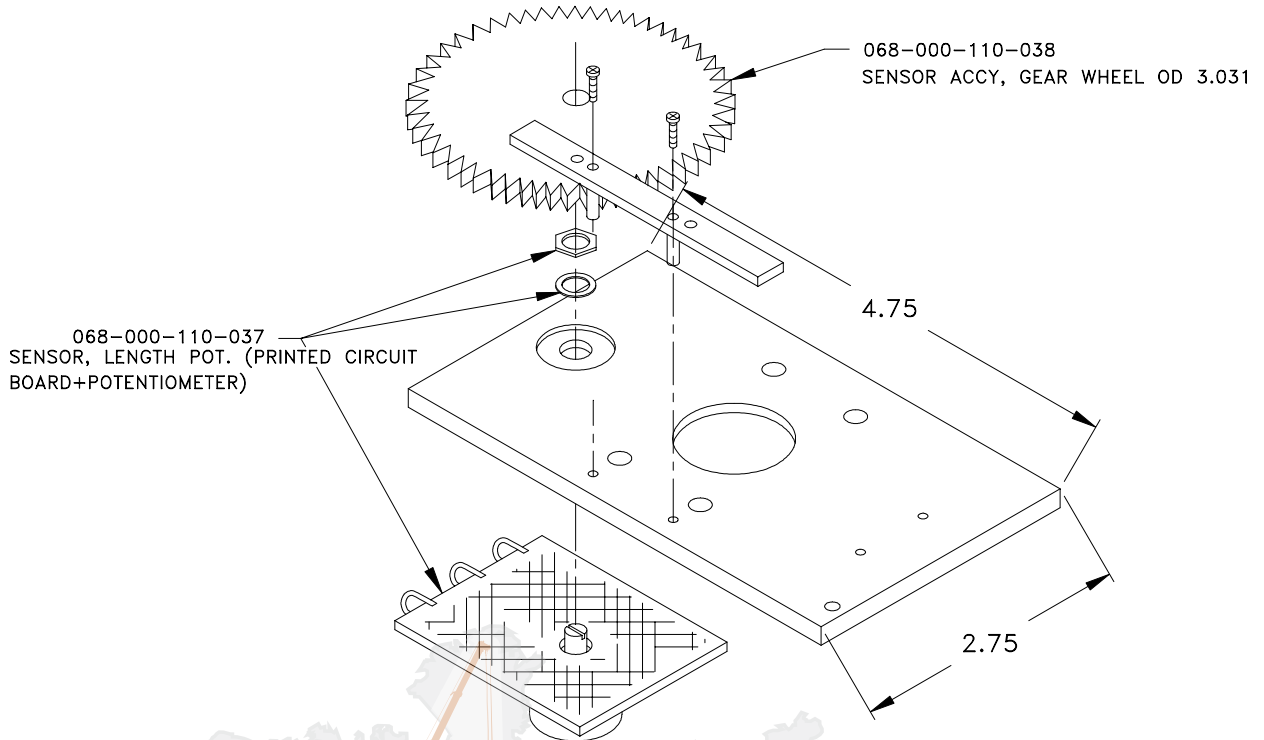

DRAWING 4. Angle Sensor WG103 Assembly 064-103-060-002

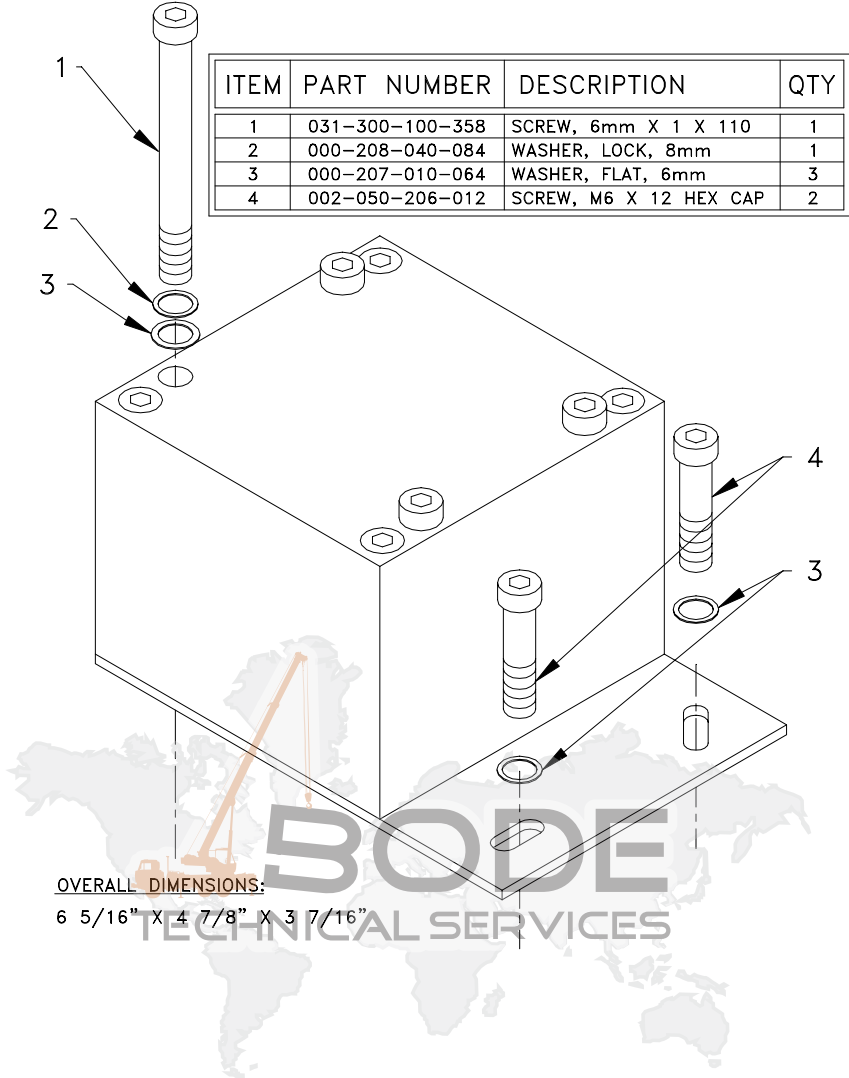

DRAWING 5. Angle Sensor WG203 Adjustment 006-420-306-001

The angle ϕ shown in drawing below, needs to be within $+0, -0.4$ of the actual angle of the boom. Check boom angle at base/heel Section only. After adjustment, compare the actual boom angle with the displayed angle at about $0, 30$ and 60 . To comply with the SAE J375 standards the displayed angle must be $+0.0$ to -2.0 of the actual angle.

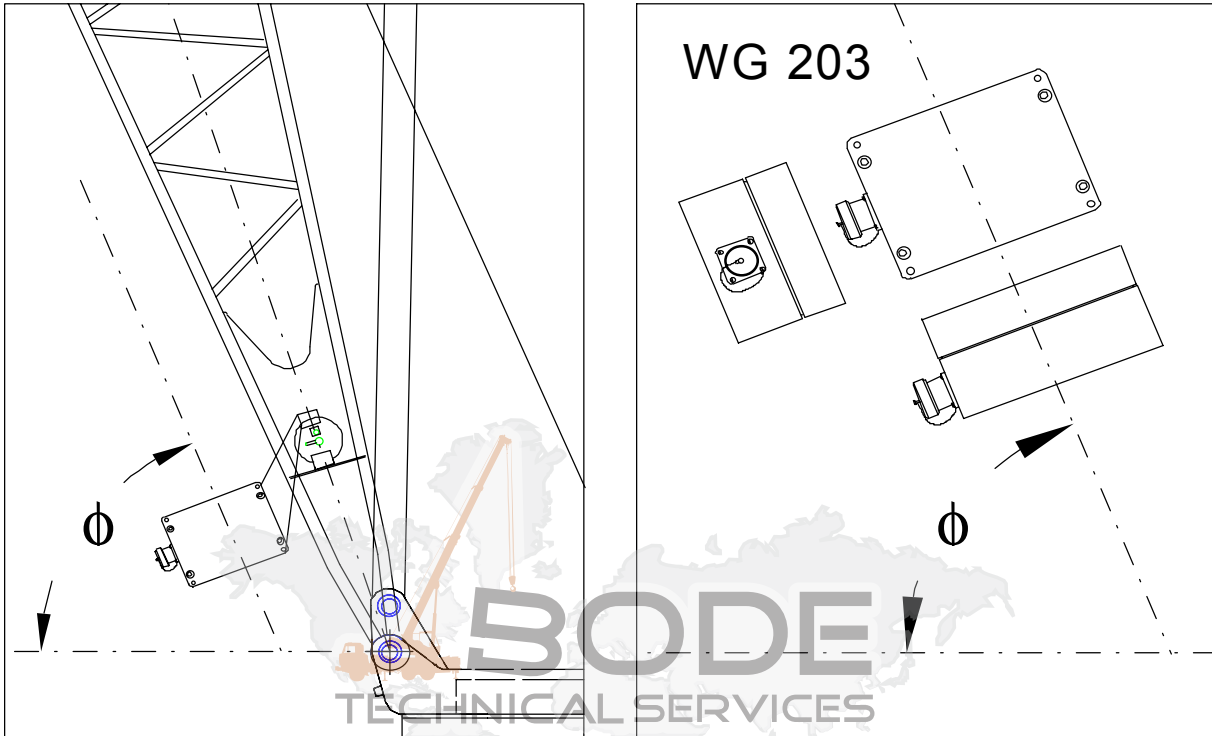

DRAWING 6. Anti-Two Block Switch 031-002-060-011

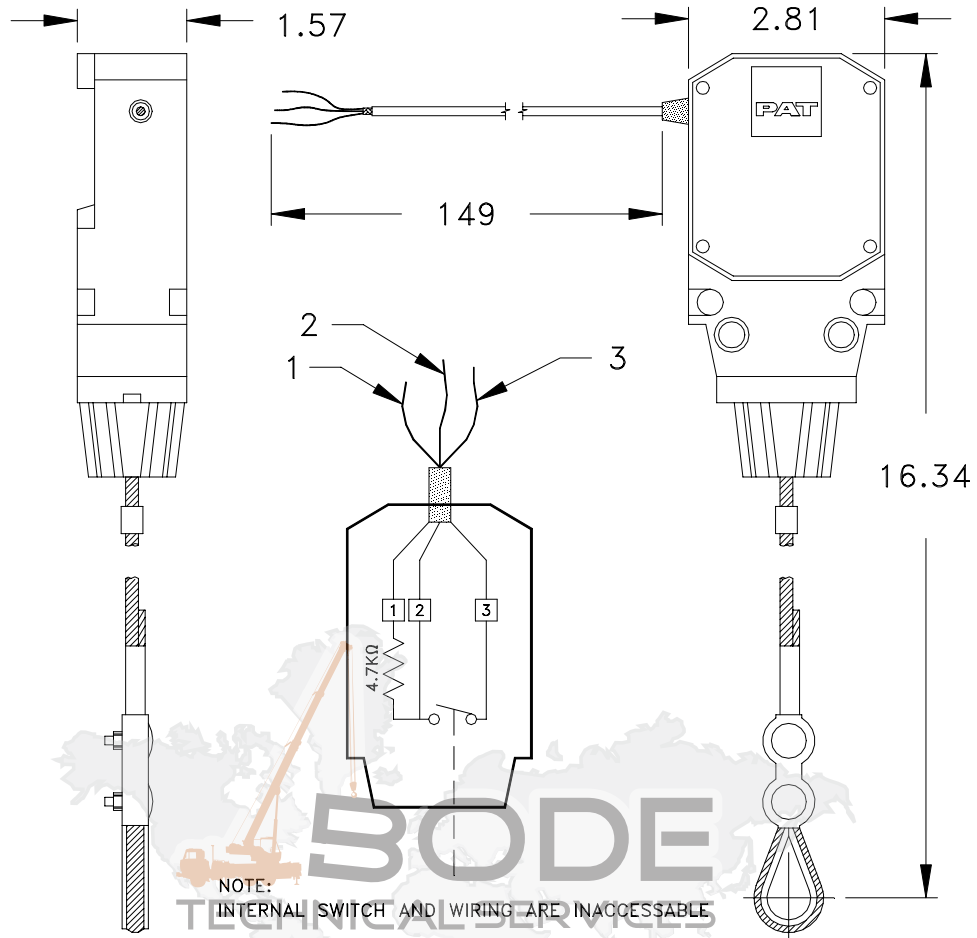

DRAWING 7. Pressure Transducer 044-213-060-001

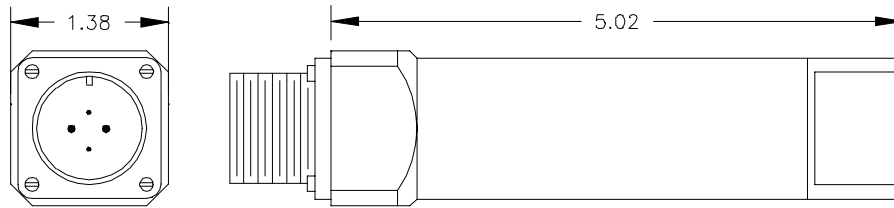

DRAWING 8. Pressure Transducer Cable Assembly

(Part Number is depends cable length)

ITEM	PART NUMBER	QTY	DESCRIPTION
1	031-300-100-197	1	CONNECTOR, CANNON, 4-SOCKET PLUG
2	003-101-013-001	1	CONNECTOR ACCY, HOUSING, #16 x PG 11
3	020-903-200-200	1	HARDWARE, O-RING, CONNECTOR HOUSING #16
4	123-429-900-400	1	CONNECTOR ACCY, DUST COVER, PLUG END, #16
5	021-441-090-711	1	STRAIN RELIEF, PG11 BLACK GROMMET
6	031-300-100-447	1	SCREW, 3mm x 5mm SLOTTED MACHINE
7	031-300-100-145	*ft	CABLE, 4 x 0.5 D.S.

*ft - LENGTH IS SPECIFIC TO MACHINE

NOTE: SCREW TO HOUSING CONNECTION MUST BE WATER TIGHT.

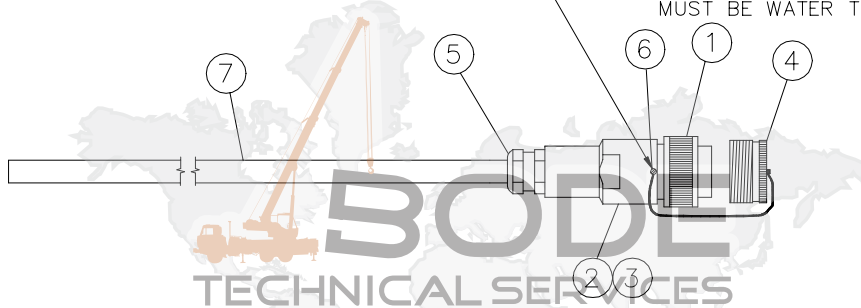

NOTES:

- ① OUTER SHIELD CONNECTED TO STRAIN RELIEF INSERT.
- ② INNER SHIELD TO BE CUT AND INSULATED.

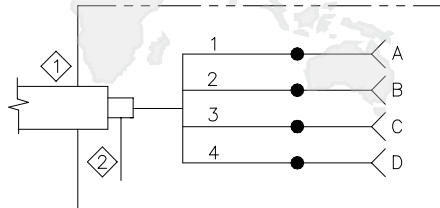

DRAWING 9. Jumper Cable Assembly for Extension 031-300-103-541

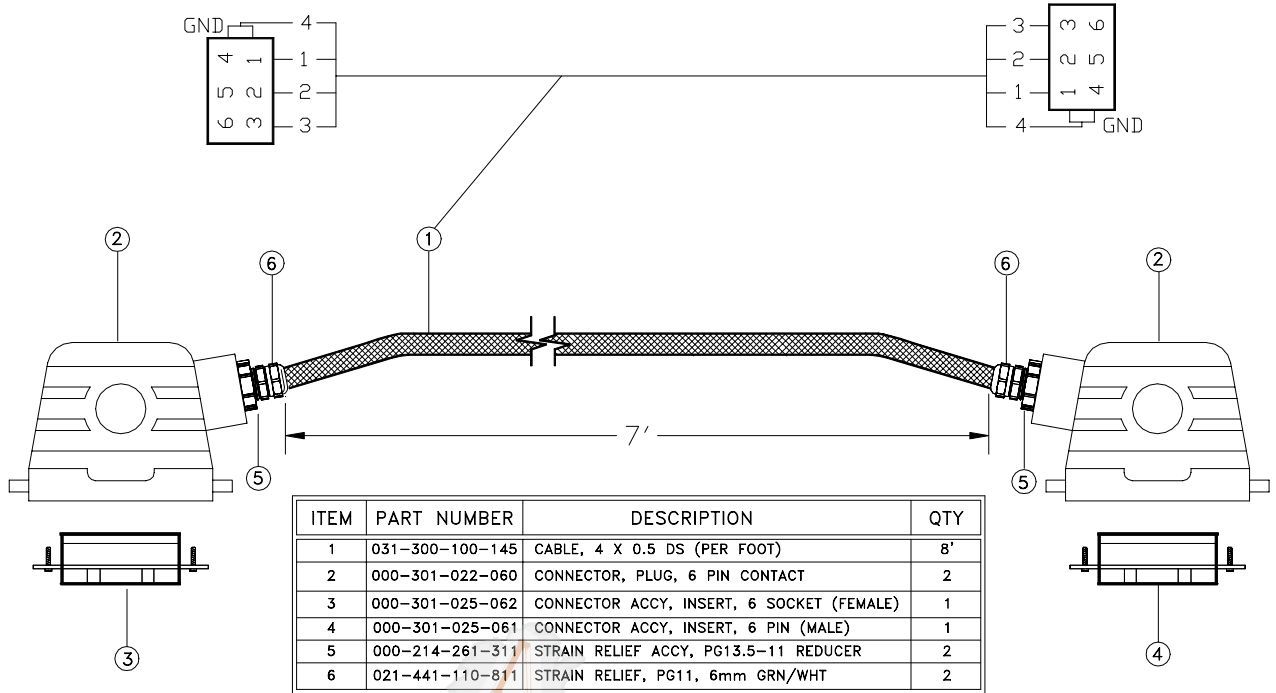

DRAWING 10. EPROM replacement in Central Unit

1. Remove cover, from central unit.

CAUTION: Before handling the EPROM, discharge any static electricity from your body by touching a grounded point. The EPROM could be damaged by static electricity.

2. Remove the old DATA EPROM, from the main board. Be careful to pull the EPROM out, without bending the legs. Refer to drawing above.

NOTE: The notch on the EPROM and in the socket determines the correct orientation of the EPROM.

Refer to the drawing below for correct EPROM locations.

3. Carefully align the new EPROM legs with the socket and push the EPROM into place. Be careful not to bend any of the legs.
4. Install the cover and tighten screws, making sure the rubber gasket, is positioned correctly, to prevent any moisture, from entering the central unit.

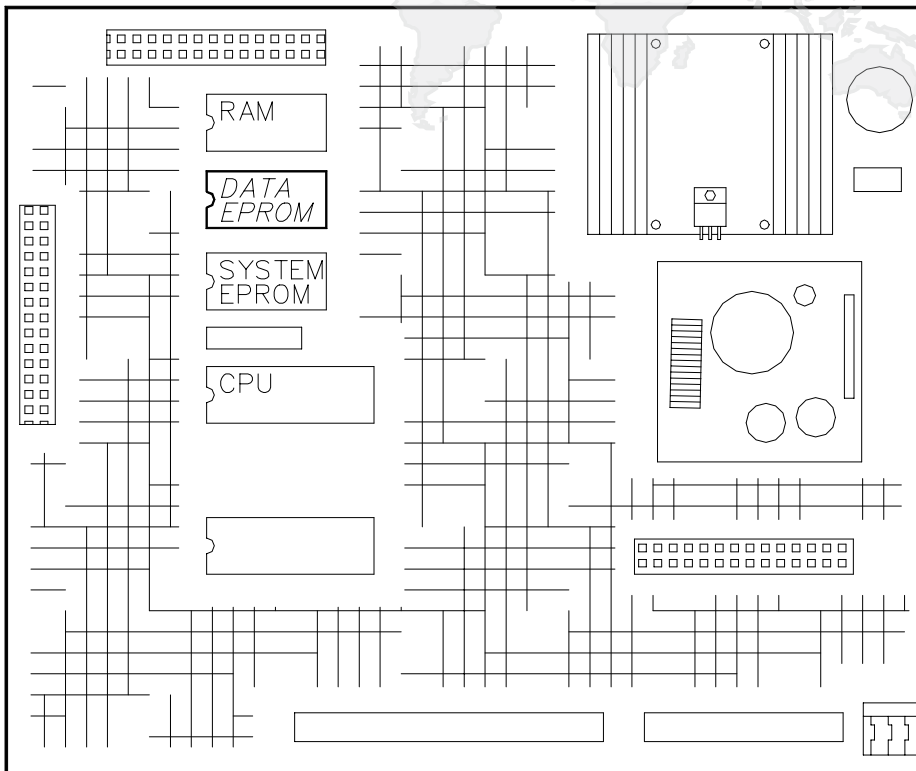
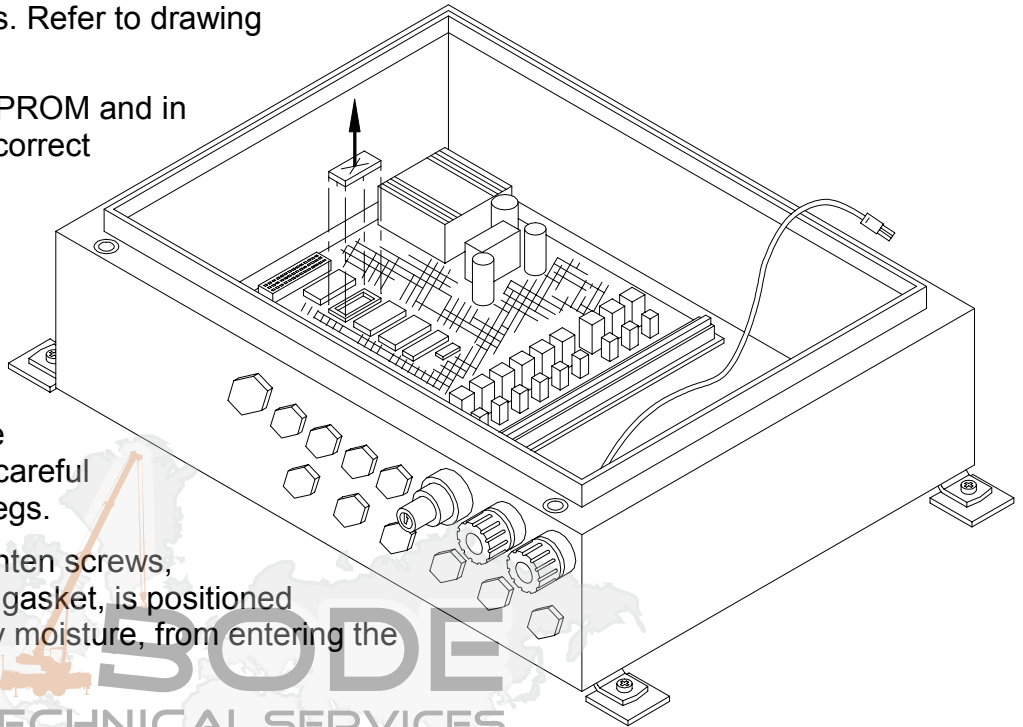

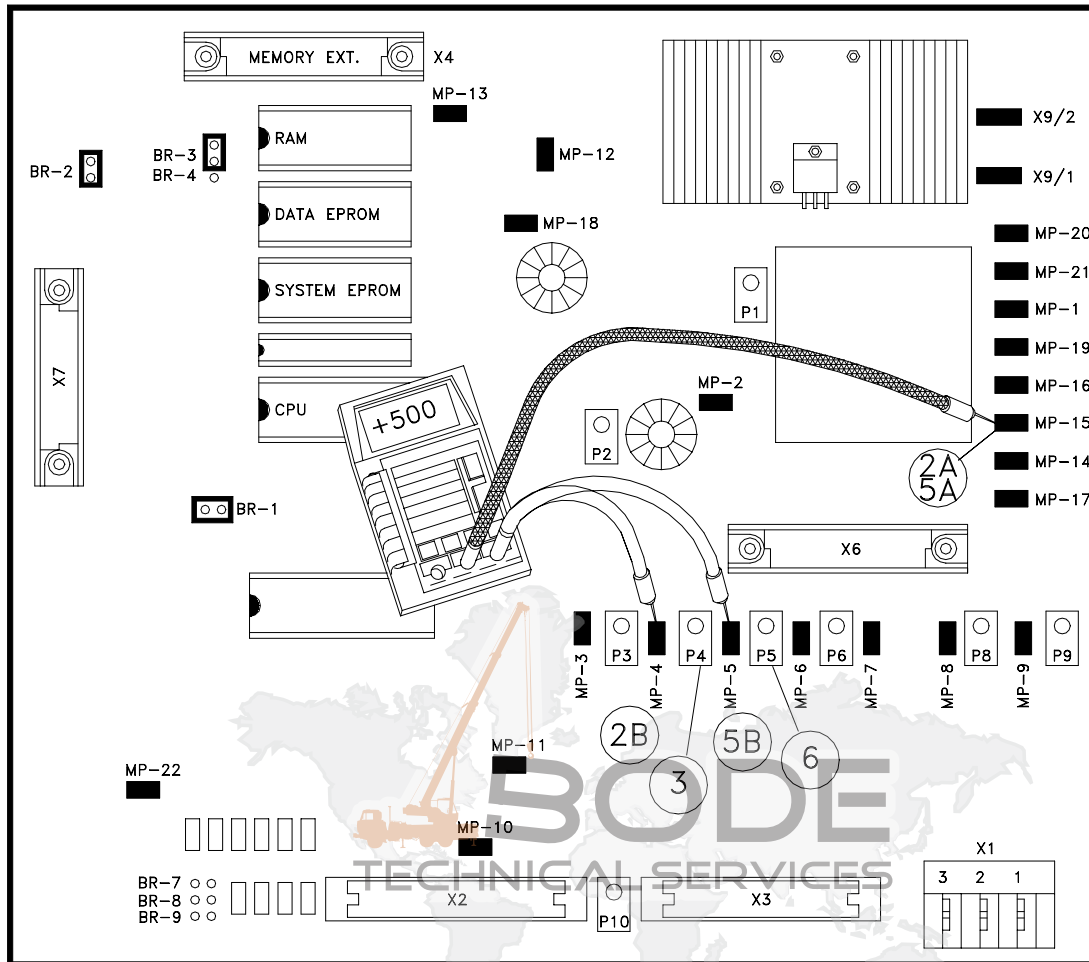
DRAWING 11. Main Board - Piston & Rod Pressure Channel Zero Point Adjustment

1. LOWER BOOM ALL THE WAY DOWN (NO REST PRESSURE) THEN DISCONNECT HYDRAULIC HOSE FROM THE PISTON SIDE PRESSURE TRANSDUCER.
2. CONNECT A DIGITAL VOLTMETER TO MAIN P.C. BOARD
 - A) BLACK (-) LEAD TO MP15
 - B) RED (+) LEAD TO MP4
3. ADJUST P4 TO OBTAIN A READING OF 0.500 VOLTS (500MV) ON METER.
4. DISCONNECT HYDRAULIC HOSE FROM THE ROD SIDE PRESSURE TRANSDUCER.
5. CONNECT A DIGITAL VOLTMETER TO MAIN P.C. BOARD
 - A) BLACK (-) LEAD TO MP15
 - B) RED (+) LEAD TO MP5
6. ADJUST P5 TO OBTAIN A READING OF 0.500 VOLTS (500MV) ON METER.
7. RECONNECT HYDRAULIC HOSES TO PRESSURE TRANSDUCERS, THEN BLEED THE AIR FROM HYDRAULIC LINES.

DRAWING 12. Central Unit Electrical Diagram

Refer to Drawings 17 to 21 for individual component wiring.

CONNECTING BOARD
024-350-300-073

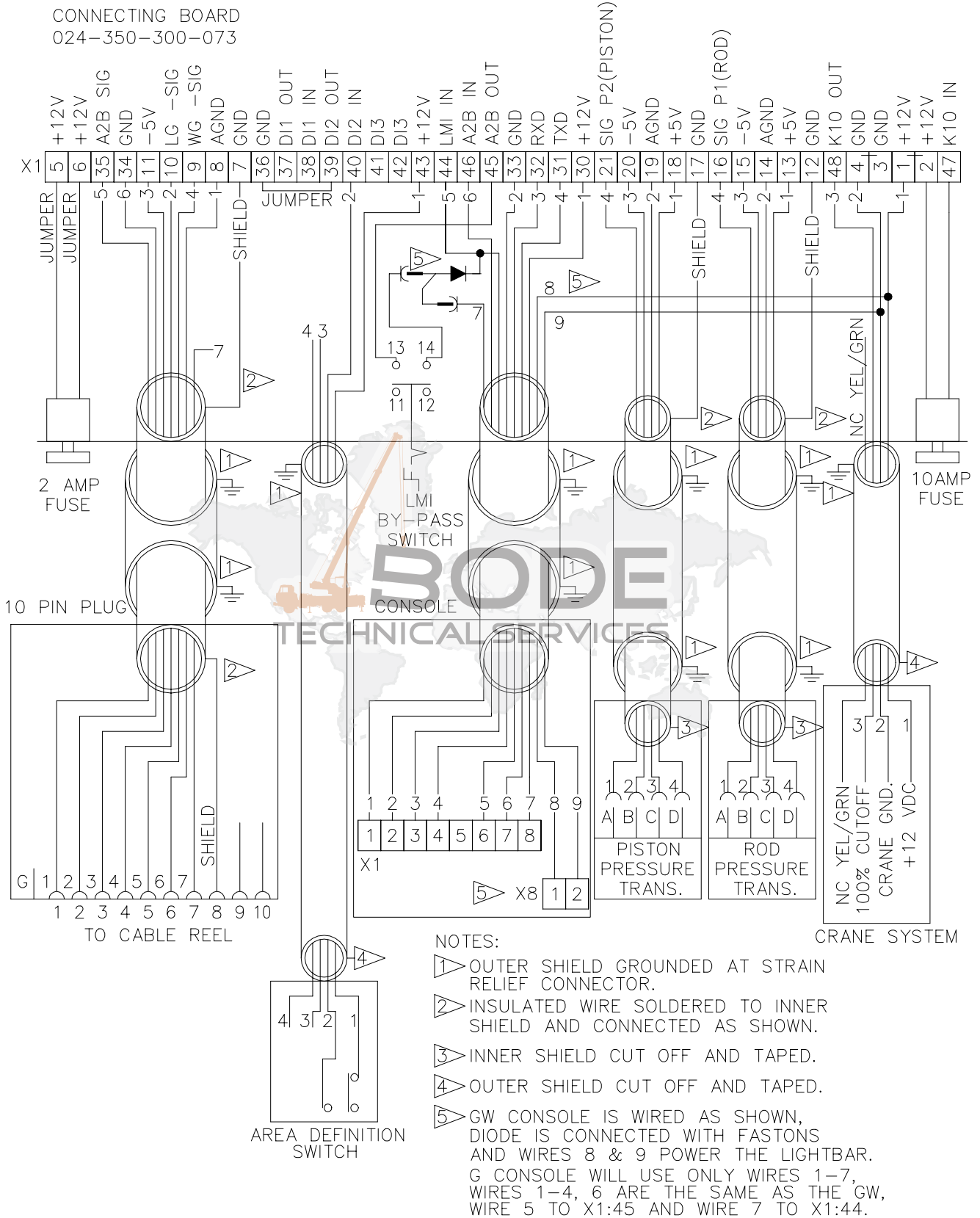

- NOTES:
- 1 OUTER SHIELD GROUNDED AT STRAIN RELIEF CONNECTOR.
 - 2 INSULATED WIRE SOLDERED TO INNER SHIELD AND CONNECTED AS SHOWN.
 - 3 INNER SHIELD CUT OFF AND TAPED.
 - 4 OUTER SHIELD CUT OFF AND TAPED.
 - 5 GW CONSOLE IS WIRED AS SHOWN, DIODE IS CONNECTED WITH FASTONS AND WIRES 8 & 9 POWER THE LIGHTBAR. G CONSOLE WILL USE ONLY WIRES 1-7, WIRES 1-4, 6 ARE THE SAME AS THE GW, WIRE 5 TO X1:45 AND WIRE 7 TO X1:44.

DRAWING 13. Cable Reel Electrical Diagram

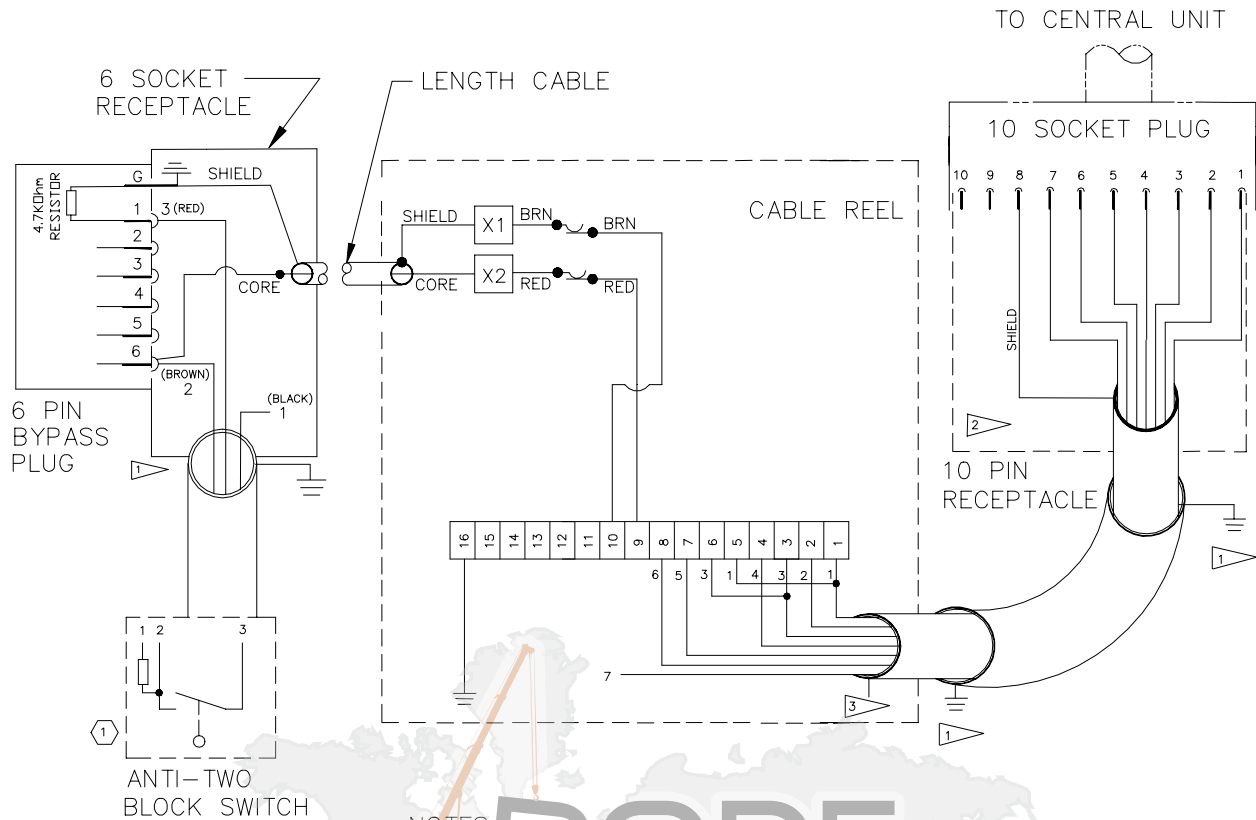

NOTES:

- 1 OUTER SHIELD GROUNDED AT STRAIN RELIEF CONNECTOR
- 2 INNER SHIELD INSULATED AND CONNECTED AS SHOWN
- 3 INNER SHIELD CUT OFF AND TAPED
- 4 OUTER SHIELD INSULATED AND CONNECTED AS SHOWN
- 5 SWITCH PREWIRED AND POTTED

DRAWING 14. A-Frame or Swingaway Extension Electrical Diagram

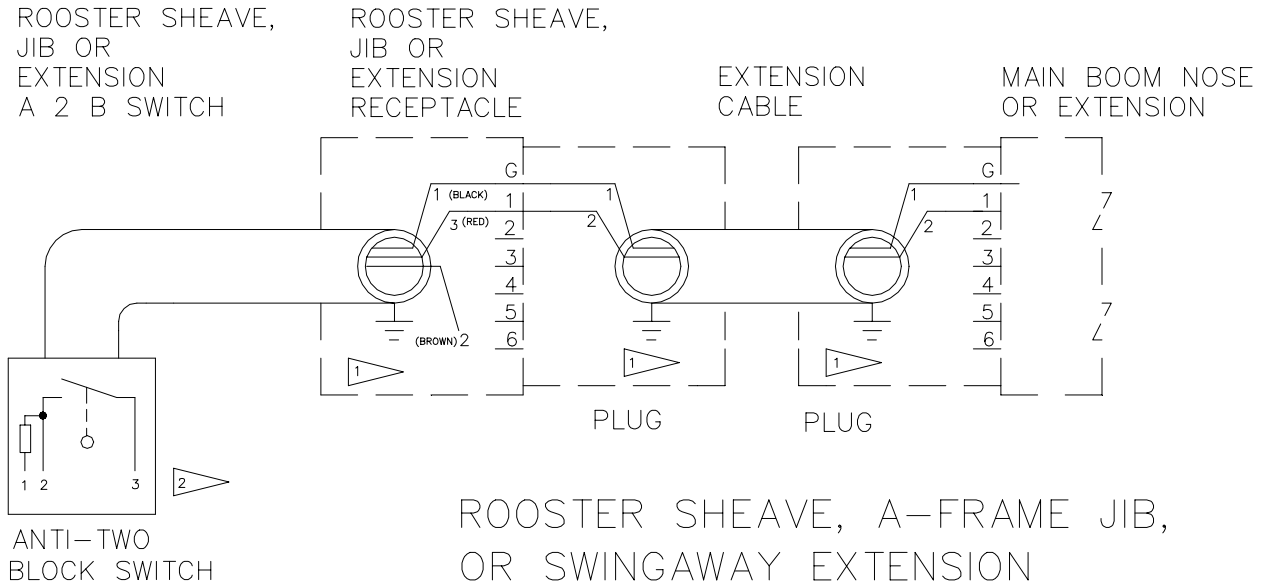

NOTE:

-  OUTER SHIELD GROUNDED AT STRAIN RELIEF CONNECTOR
-  SWITCH PREWIRED AND POTTED



DRAWING 15. Offset Swingaway Extension Electrical Diagram

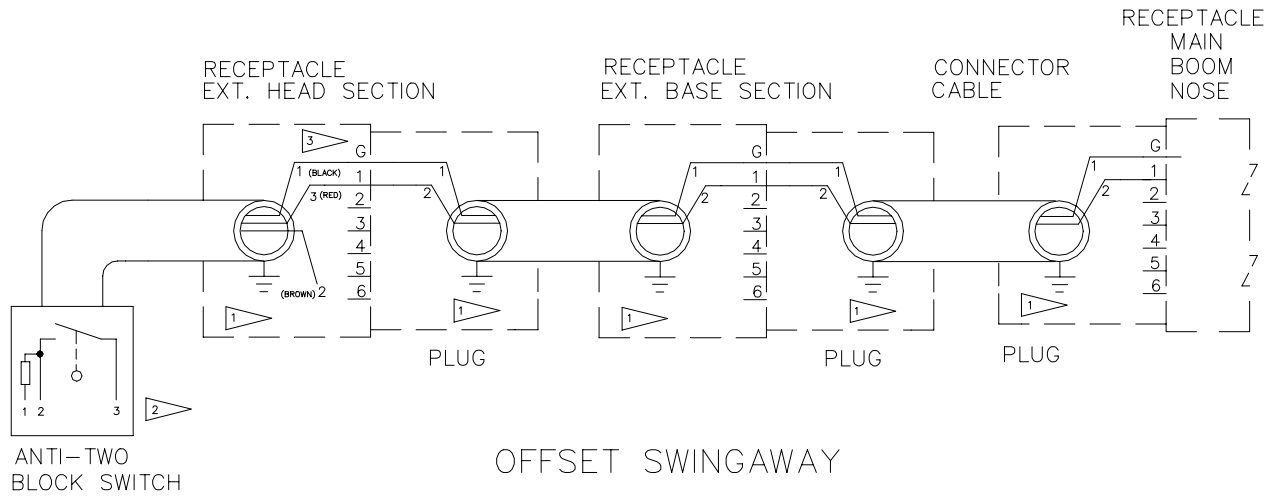

DRAWING 16. Tele Swingaway Extension Electrical Diagram

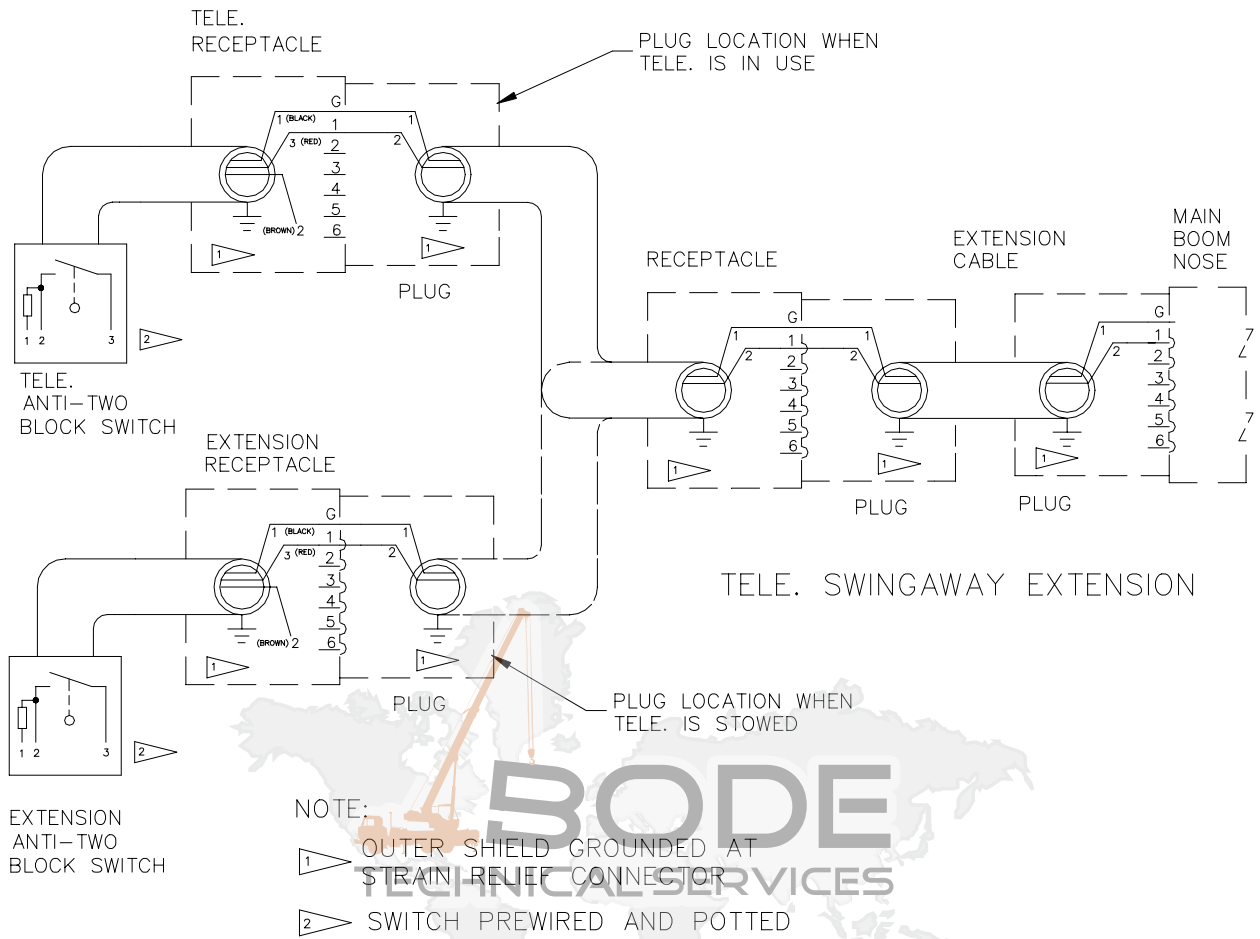

DRAWING 17. Electrical Diagram - Console to Central Unit

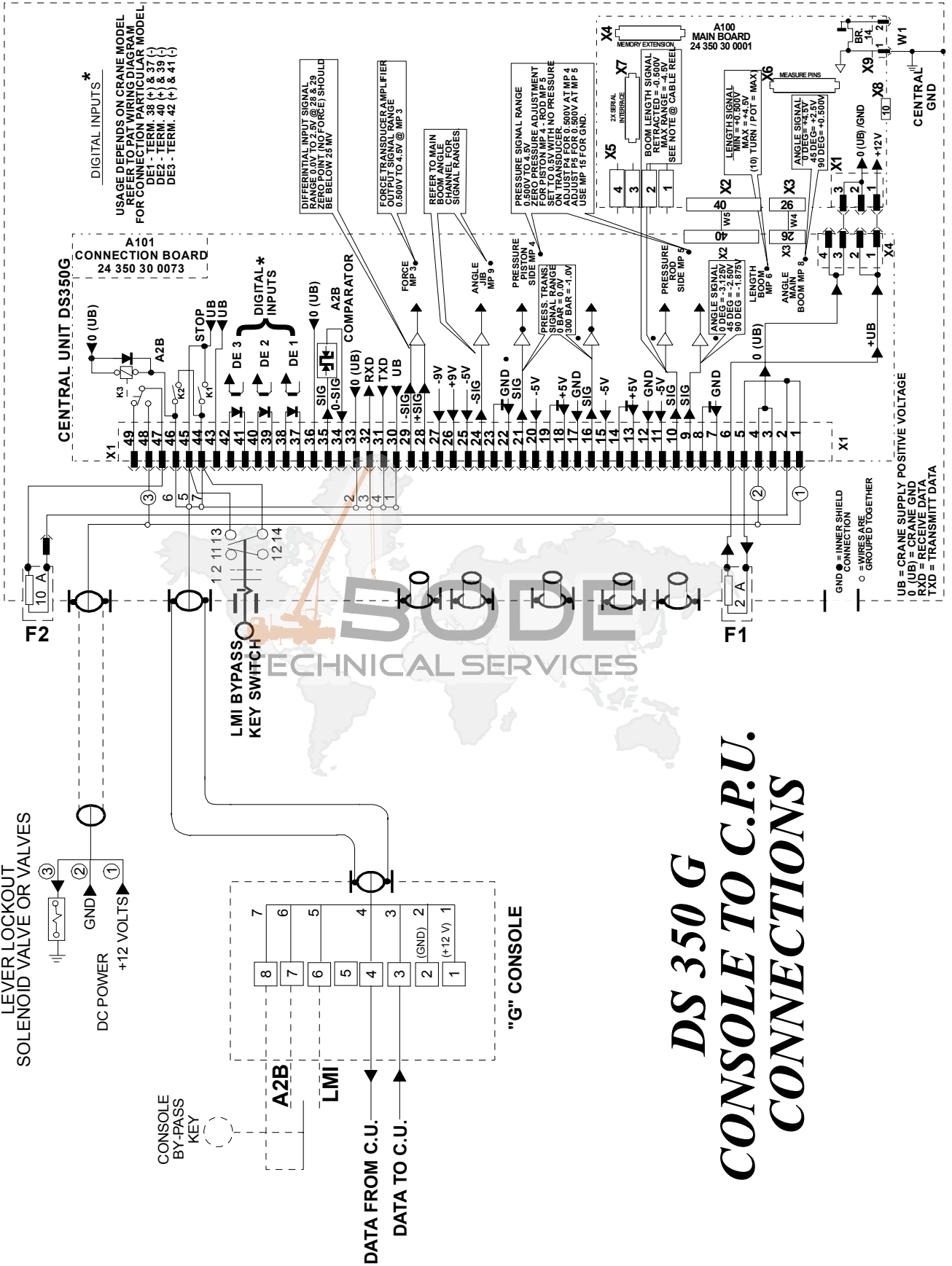

DS 350 G CONSOLE TO C.P.U. CONNECTIONS

DRAWING 18. Electrical Diagram - Console to Central Unit

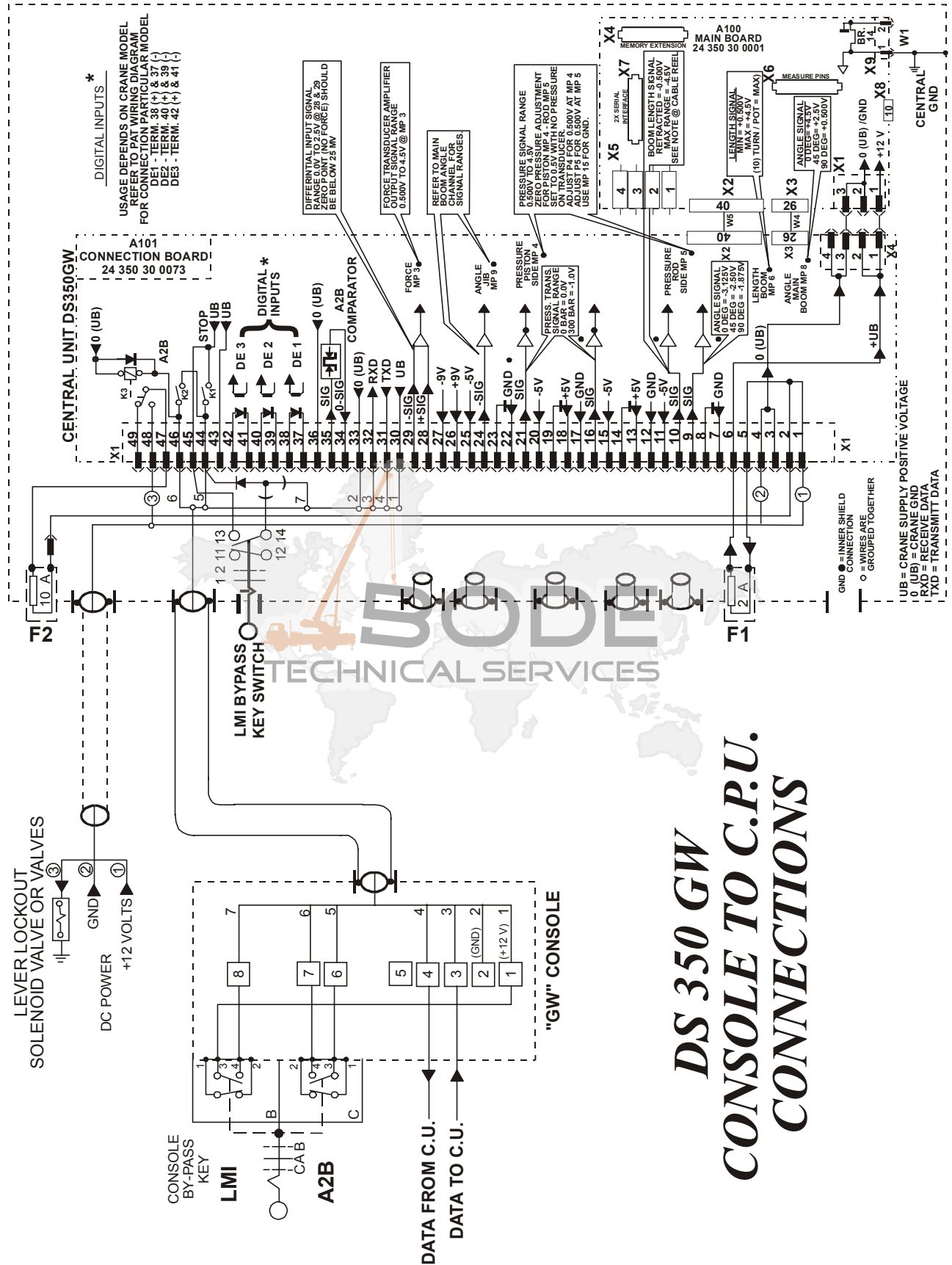

DRAWING 19. Electrical Diagram - Cable Reel to Central Unit

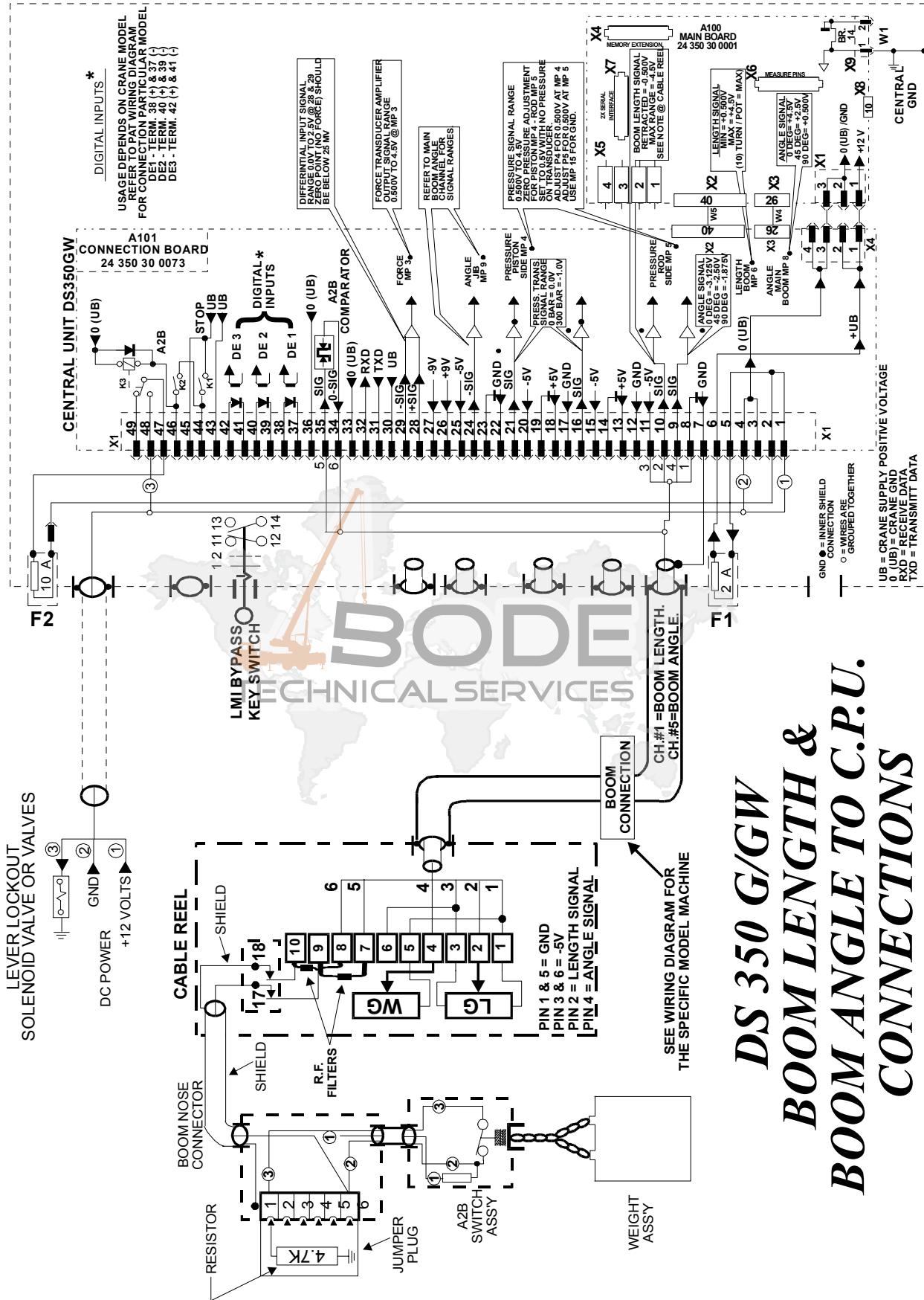

DS 350 G/GW

BOOM LENGTH & BOOM ANGLE TO C.P.U. CONNECTIONS

DRAWING 20. Electrical Diagram - Pressure Transducer to Central Unit

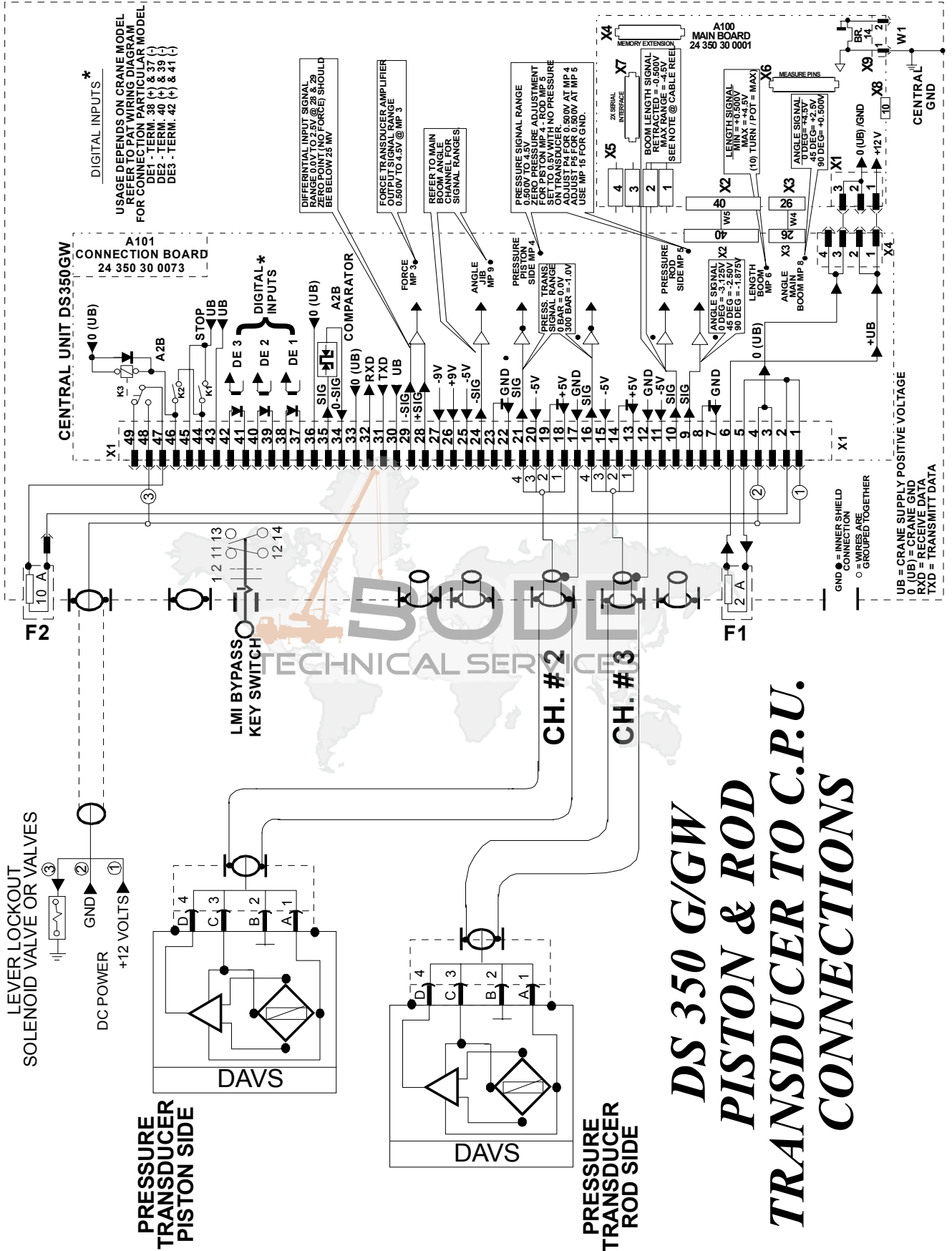

SECTION 4. THEORY

THEORY 1. Anti-Two Block & Shutoff Circuit

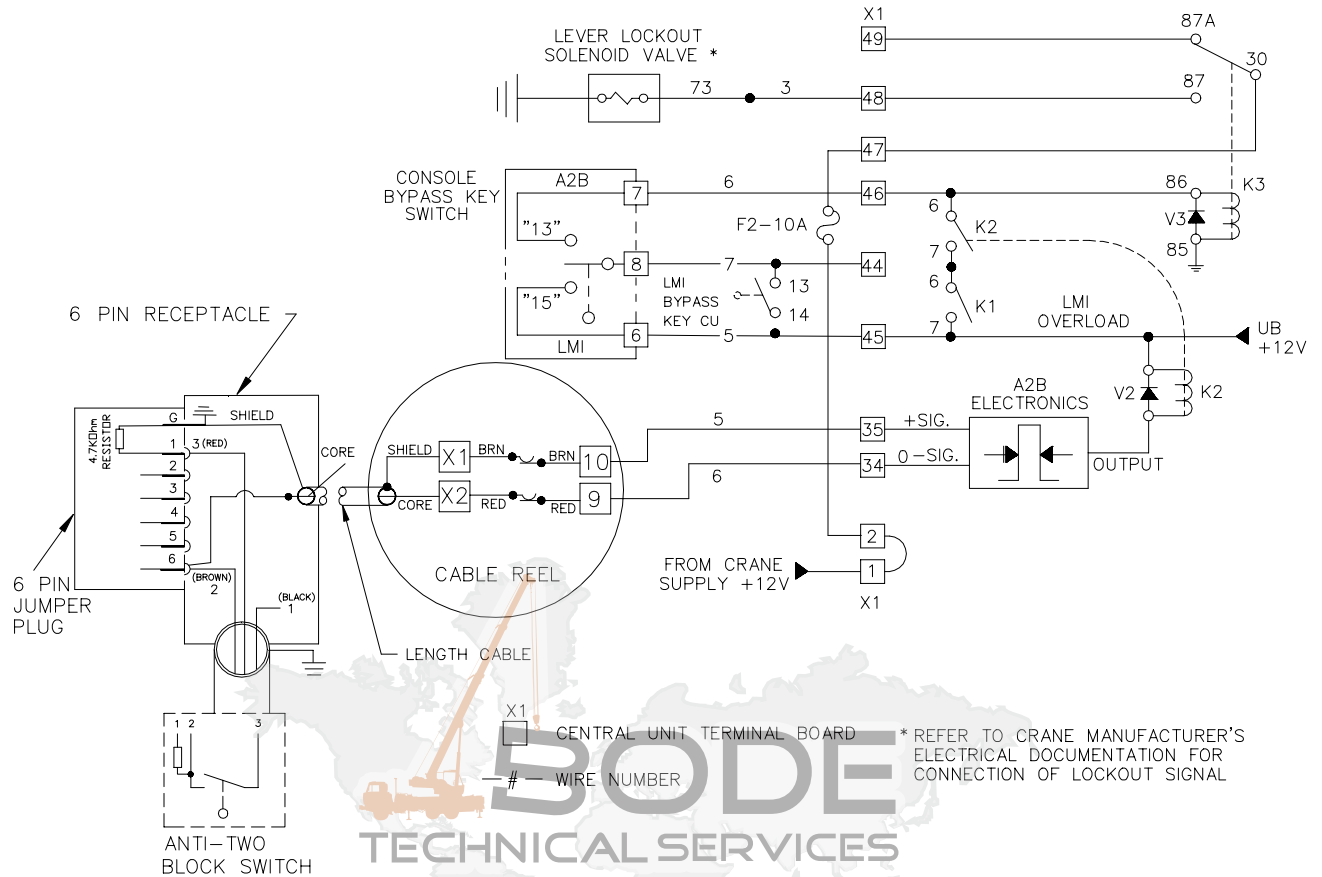

THEORY 2. Length Measuring Channel #1

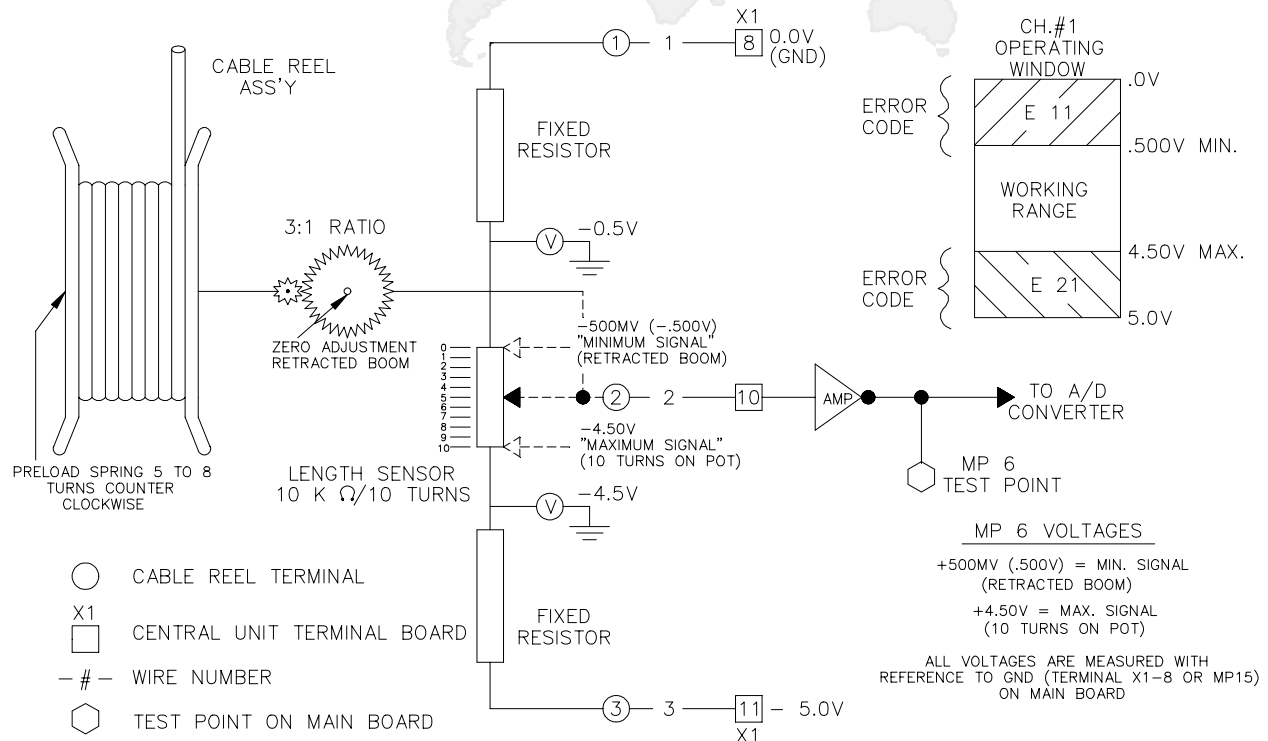

THEORY 3. Piston Side Pressure Measuring Channel #2

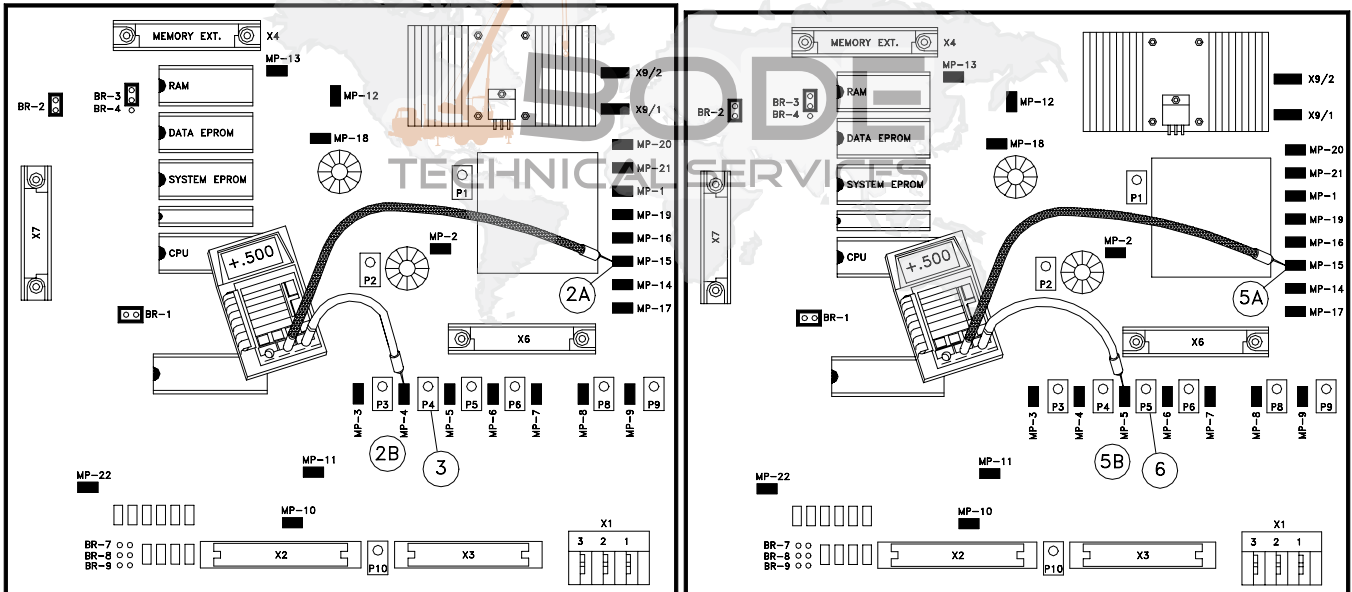
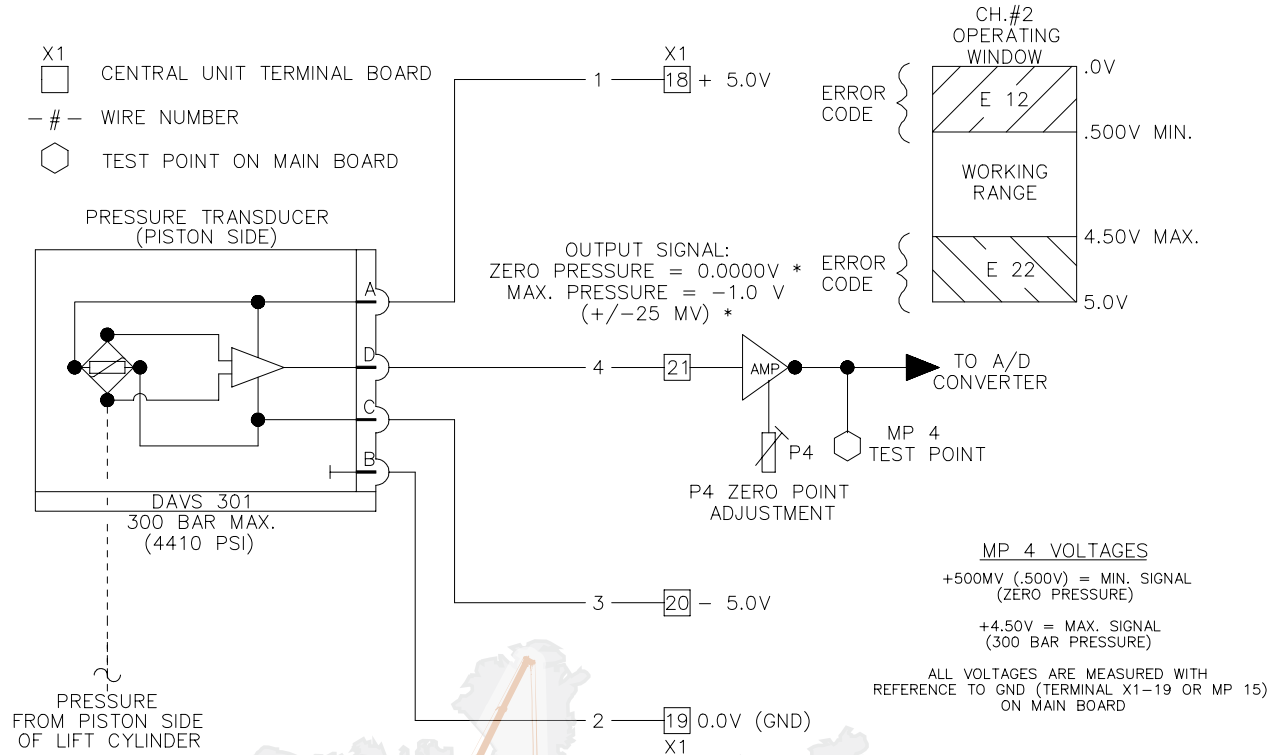

Piston Pressure Channel Zero Point Adjustment

1. Lower boom all the way down (no rest pressure) then disconnect hydraulic hose from the piston side pressure transducer.
2. Connect a digital voltmeter to main p.c. board, black (-) lead to MP15, red (+) lead to MP4
3. Adjust P4 to obtain a reading of 0.500 volts (500mv) on meter.
4. Disconnect hydraulic hose from the rod side pressure transducer.
5. Connect a digital voltmeter to main p.c. board, black (-) lead to MP15, red (+) lead to MP5
6. Adjust P5 to obtain a reading of 0.500 volts (500mv) on meter.
7. Reconnect hydraulic hoses to pressure transducers, then bleed the air from hydraulic lines.

THEORY 4. Rod Side Pressure Measuring Channel #3

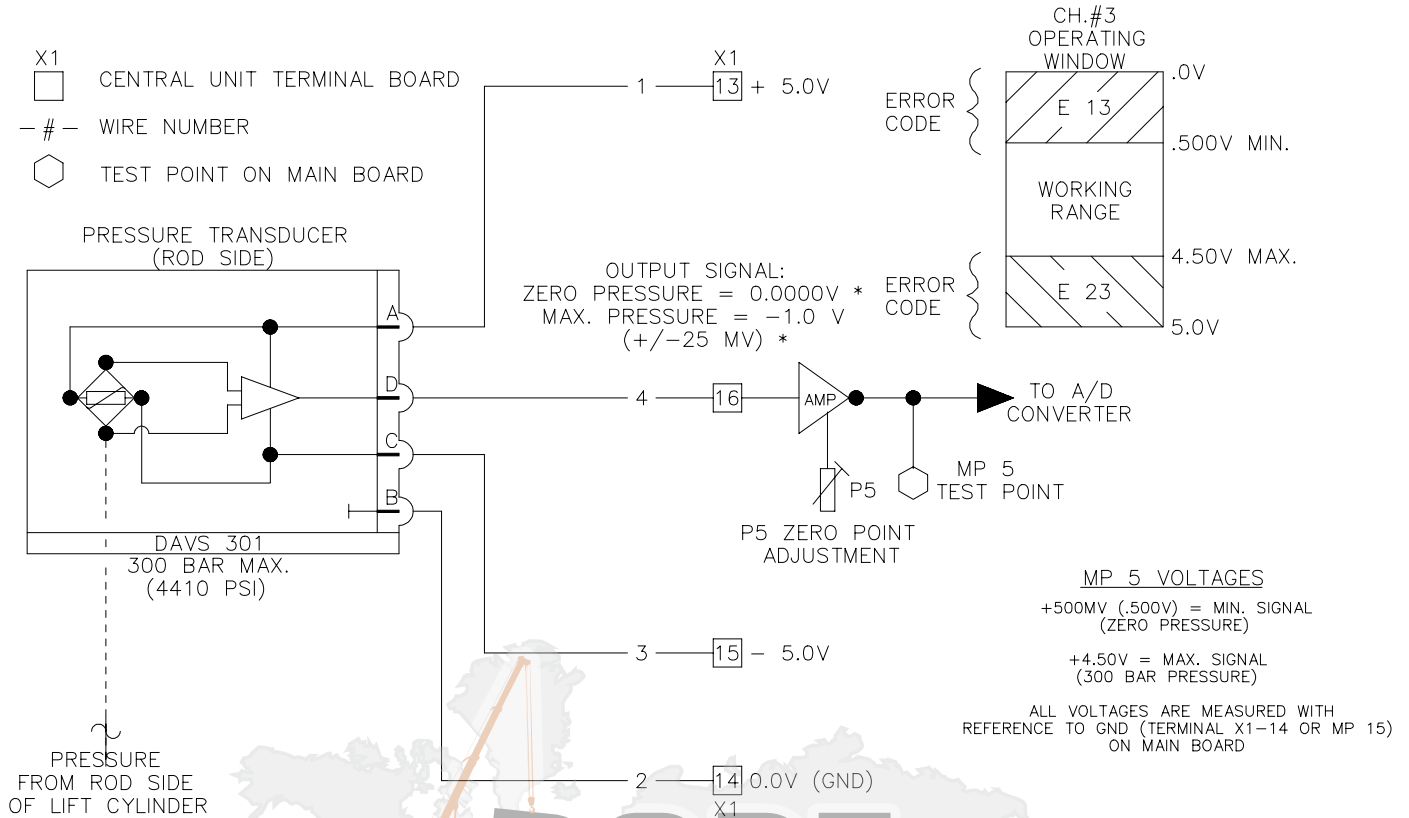

THEORY 5. Force Transducer Measuring Channel #4

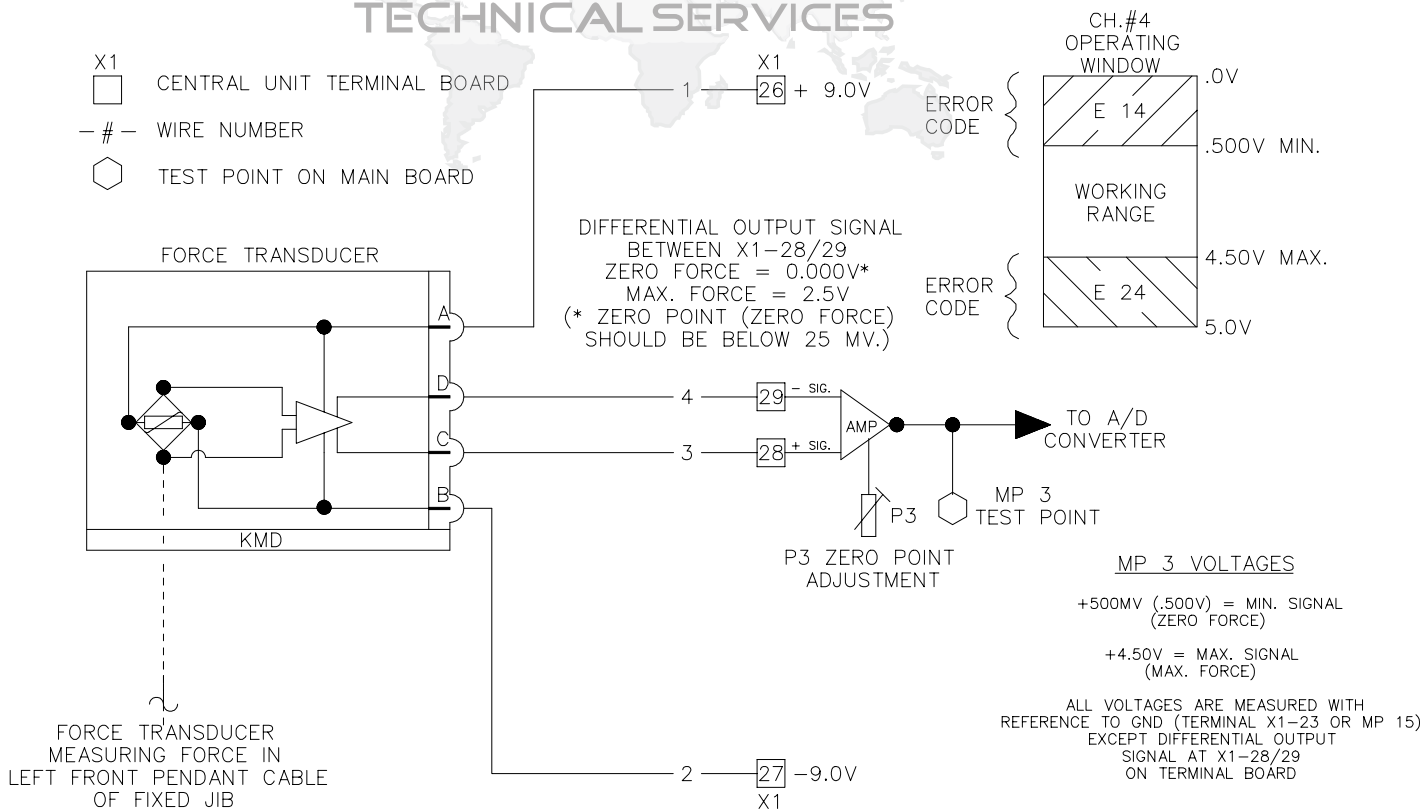

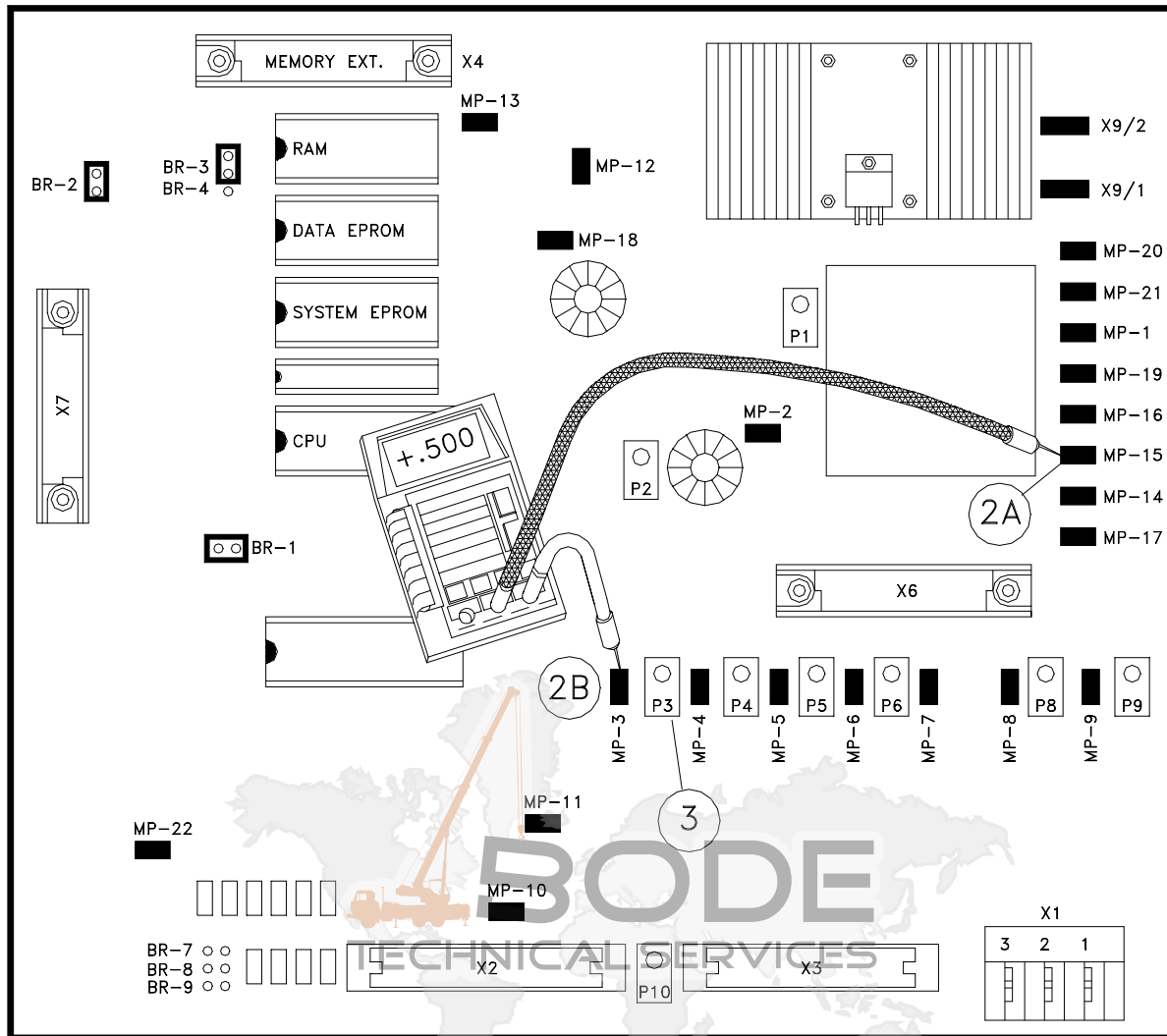

FORCE CHANNEL ZERO POINT ADJUSTMENT

1. REMOVE ALL FORCES APPLIED TO THE FORCE TRANSDUCER.
2. CONNECT A DIGITAL VOLTMETER TO MAIN P.C. BOARD
 - A) BLACK (-) LEAD TO MP15
 - B) RED (+) LEAD TO MP3
3. ADJUST P3 TO OBTAIN A READING OF 0.500 VOLTS (500MV) ON METER.

THEORY 6. Main Boom Angle Measuring Channel #5

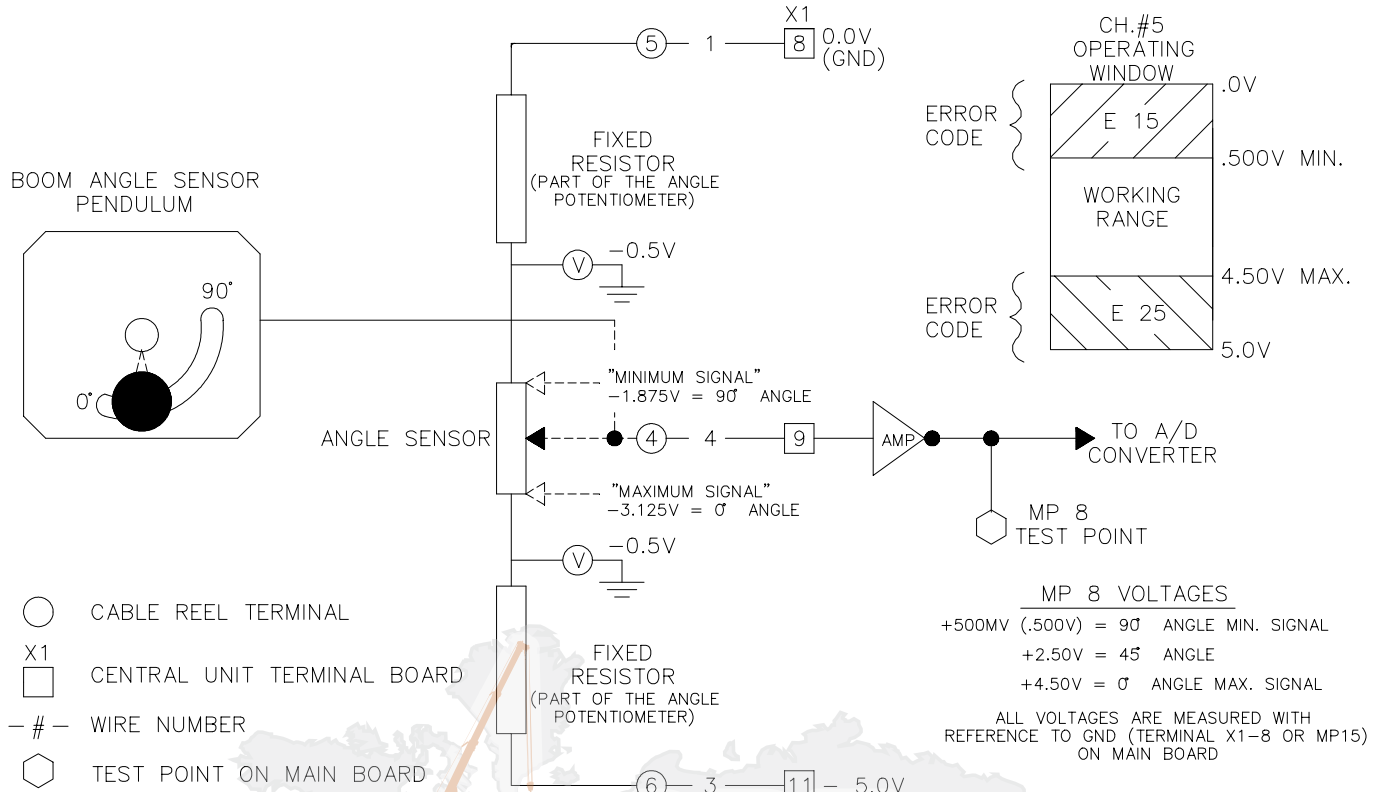

THEORY 7. Jib Angle Measuring Channel #6

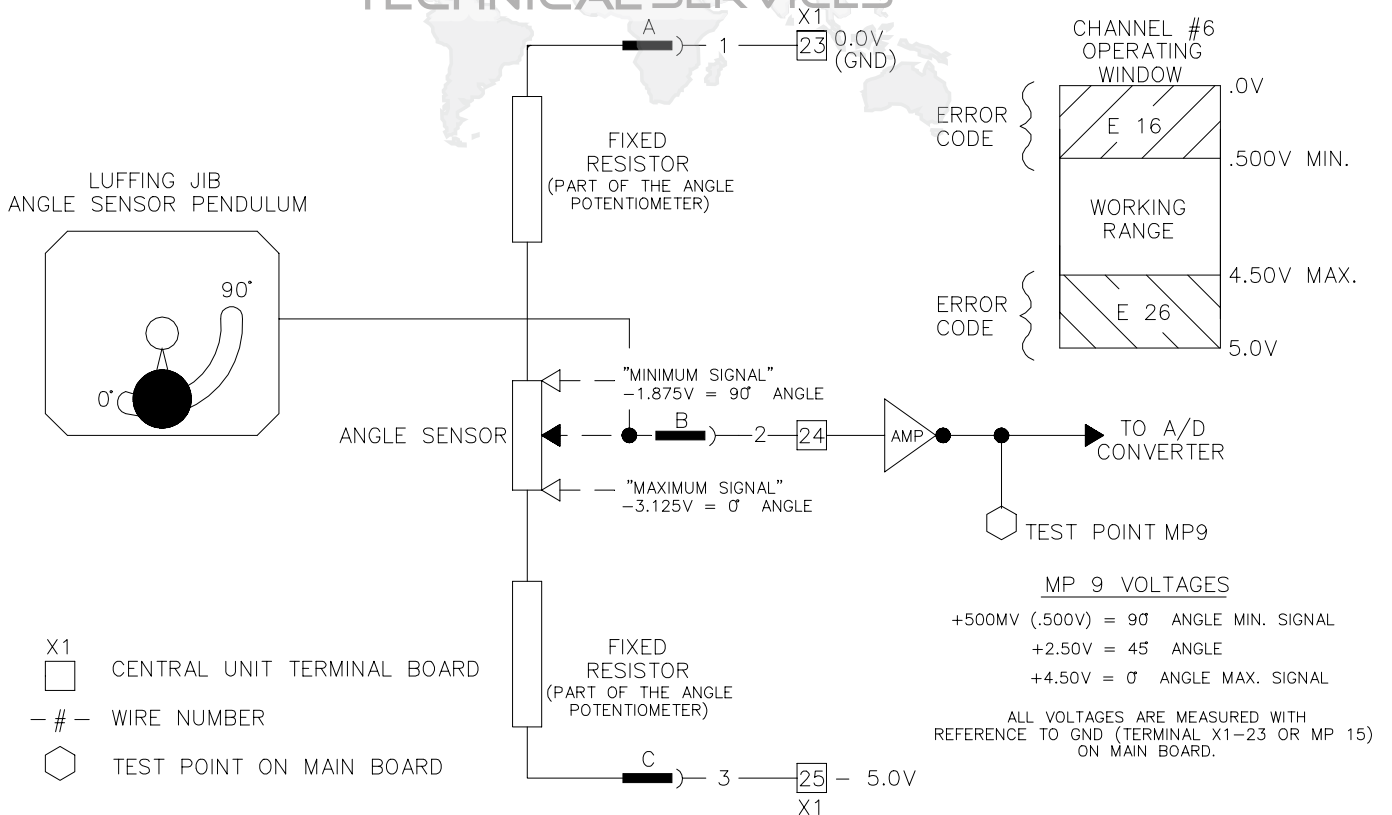

THEORY 8. BASIC ADJUSTMENT AND VOLTAGE CHECKS

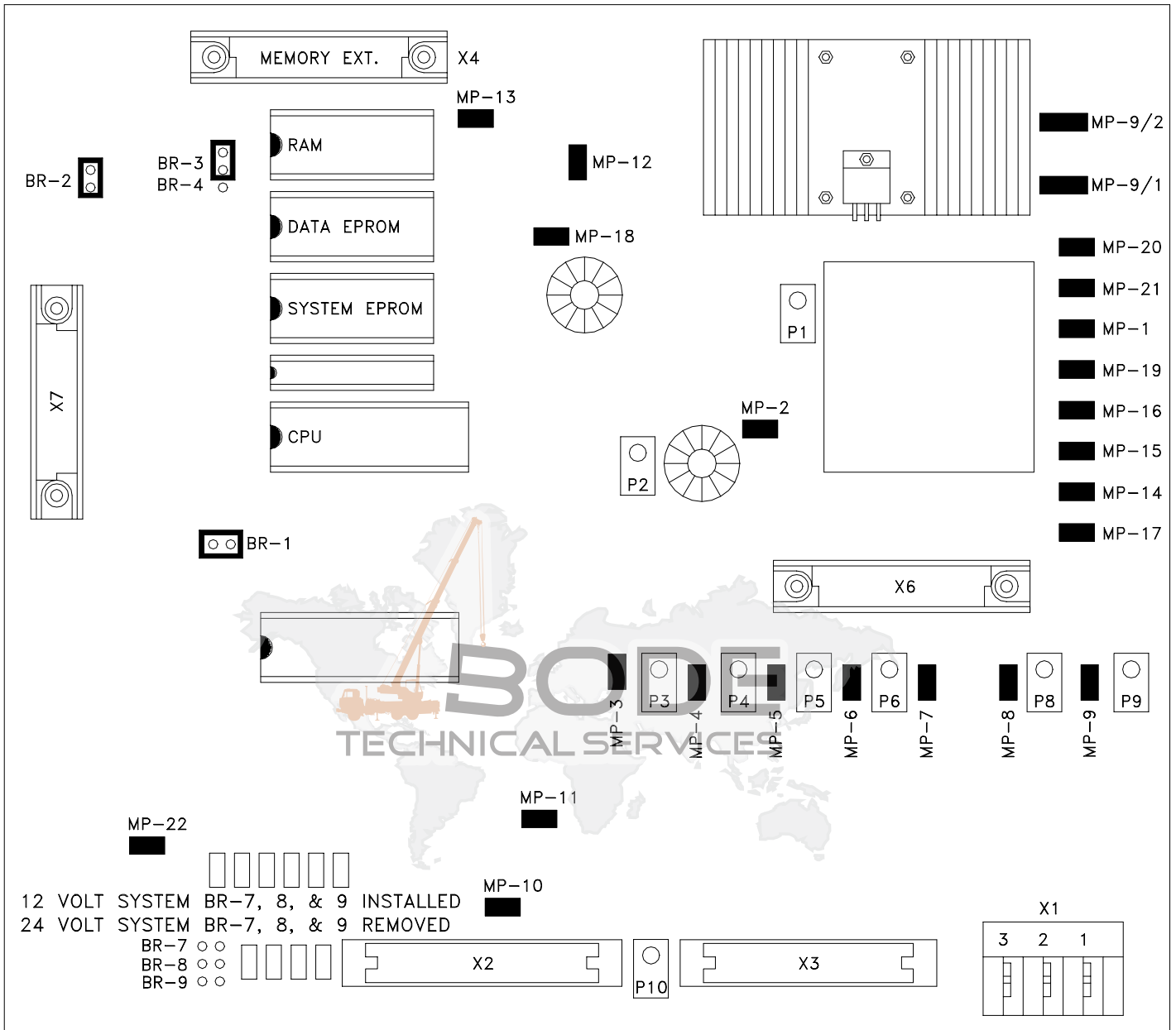

MP TEST POINTS

- | | |
|---|---------------------------|
| MP- 1 = +5V | MP-11 = GROUND |
| MP- 2 = -5V | MP-12 = +5V |
| MP- 3 = ANALOG MEASURING CHANNEL REFERENCE SOFTWARE | MP-13 = DIGITAL GROUND |
| MP- 4 = ANALOG MEASURING CHANNEL REFERENCE SOFTWARE | MP-14 = +9V |
| MP- 5 = ANALOG MEASURING CHANNEL REFERENCE SOFTWARE | MP-15 = ANALOG GROUND |
| MP- 6 = ANALOG MEASURING CHANNEL REFERENCE SOFTWARE | MP-16 = -9V |
| MP- 7 = ANALOG MEASURING CHANNEL REFERENCE SOFTWARE | MP-17 = +5V |
| MP- 8 = ANALOG MEASURING CHANNEL REFERENCE SOFTWARE | MP-18 = +5V |
| MP- 9 = ANALOG MEASURING CHANNEL REFERENCE SOFTWARE | MP-19 = -5V |
| MP-9/1 = COMPUTER GND | MP-20 = OPERATING VOLTAGE |
| MP-9/2 = CRANE GND | MP-21 = INPUT VOLTAGE |
| MP-10 = +3V REFERENCE VOLTAGE | |

MODEL: _____

S/N: _____

PAT DS350G PART #024-350-300-081 and 024-350-300-068

1. Crane Supply Voltage @ X1-1 (+) & X1-4 (GND) = VDC
2. Supply Voltage to Main Board @ X1-1 (=) & X1-3 (GND) = VDC
3. Main Board Power Supply (Reference Voltages +/- 50 MV):
 - + 9V @ Mp 14 = _____ VDC Mp 15 Ground - Force Transducer
 - 9V @ Mp 16 = _____ VDC Mp 15 Ground - Force Transducer
 - + 5V @ Mp 17 = _____ VDC Mp 15 Ground - Internal to Board
 - 5V @ Mp 19 = _____ VDC Mp 15 Ground - Internal to Board
 - + 5V @ Mp 1 = _____ VDC Mp 15 Ground - Internal to Board
 - 5V @ Mp 2 = _____ VDC Mp 15 Ground - Jib-Angle, Length/Angle, Rod, Piston Supply
 - + 5V @ Mp 18 = _____ VDC Mp 15 Ground - Piston & Rod Supply
 - + 5V @ Mp 12 = _____ VDC Mp 13 Ground - Internal to Board
 - +12V @ Mp21 = _____ VDC Mp 15 Ground - Internal to Board
 - + 6 V @ Mp 20= _____ VDC Mp 15 Ground - Internal to Board
4. Boom Length: (Mp 15 Ground for Meter)
 - Fully Retracted _____ Ft. _____ VDC @ X1-10 _____ DC @ Mp 6
 - Fully Extended _____ Ft. _____ VDC @ X1-10 _____ DC @ Mp 6
 - 5 Volt Reference Voltage _____ VDC @ X1-11
5. Boom Angle: (MP 15 Ground for Meter)
 - Minimum Angle _____ VDC @ X1-9 _____ VDC @ Mp8
 - Maximum Angle _____ VDC @ X1-9 _____ VDC @ Mp8
 - 5 Volt Reference Voltage _____ VDC @ X1-11
6. Pressure Transducers: (Mp 15 Ground for Meter)
 - Piston Zero Point _____ VDC @ X1-21 _____ VDC @ Mp 4
 - Rod Zero Point _____ VDC @ X1-16 _____ VDC @ Mp 5
 - +5 Volt Reference Voltage _____ VDC @ X1-13 & 18
 - 5 Volt Reference Voltage _____ VDC @ X1-15 & 20

5. TROUBLESHOOTING FLOW CHARTS

1. GENERAL FLOWCHART

This section explains how to handle a problem that may arise with the PAT Load Moment Indicator System-PAT DS350G. The procedures are easy to follow and are given in flowcharts on the following pages. Start with the general flowchart below which will guide you to one of the more detailed flowcharts shown in this section.

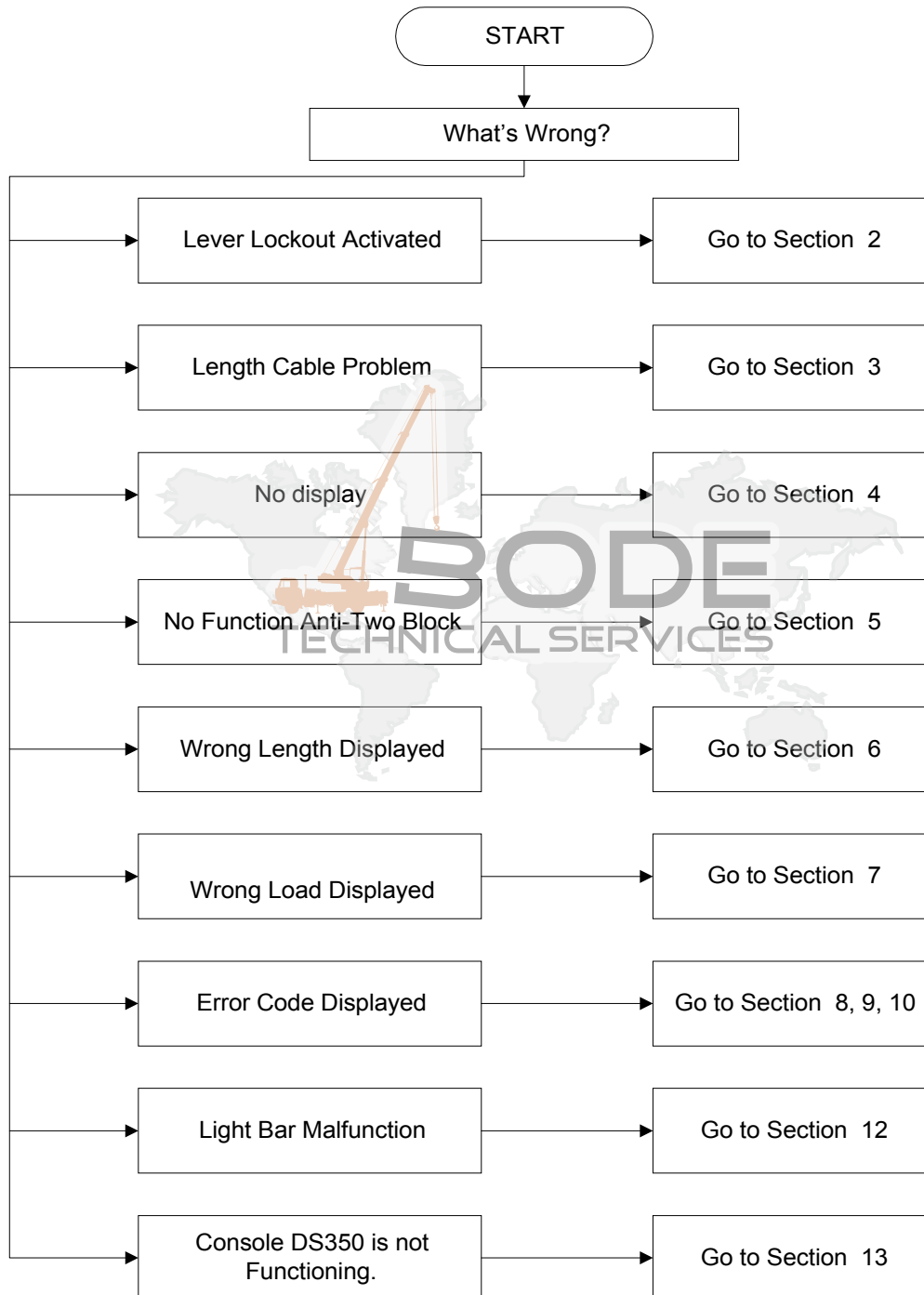

2. LEVER LOCKOUT ACIVATED

PROBLEM: The lever lockout system of the crane is activated. Crane movements “hoist up”, “telescope out”, and “boom down” are stopped. Crane is not in overload or two-block condition.

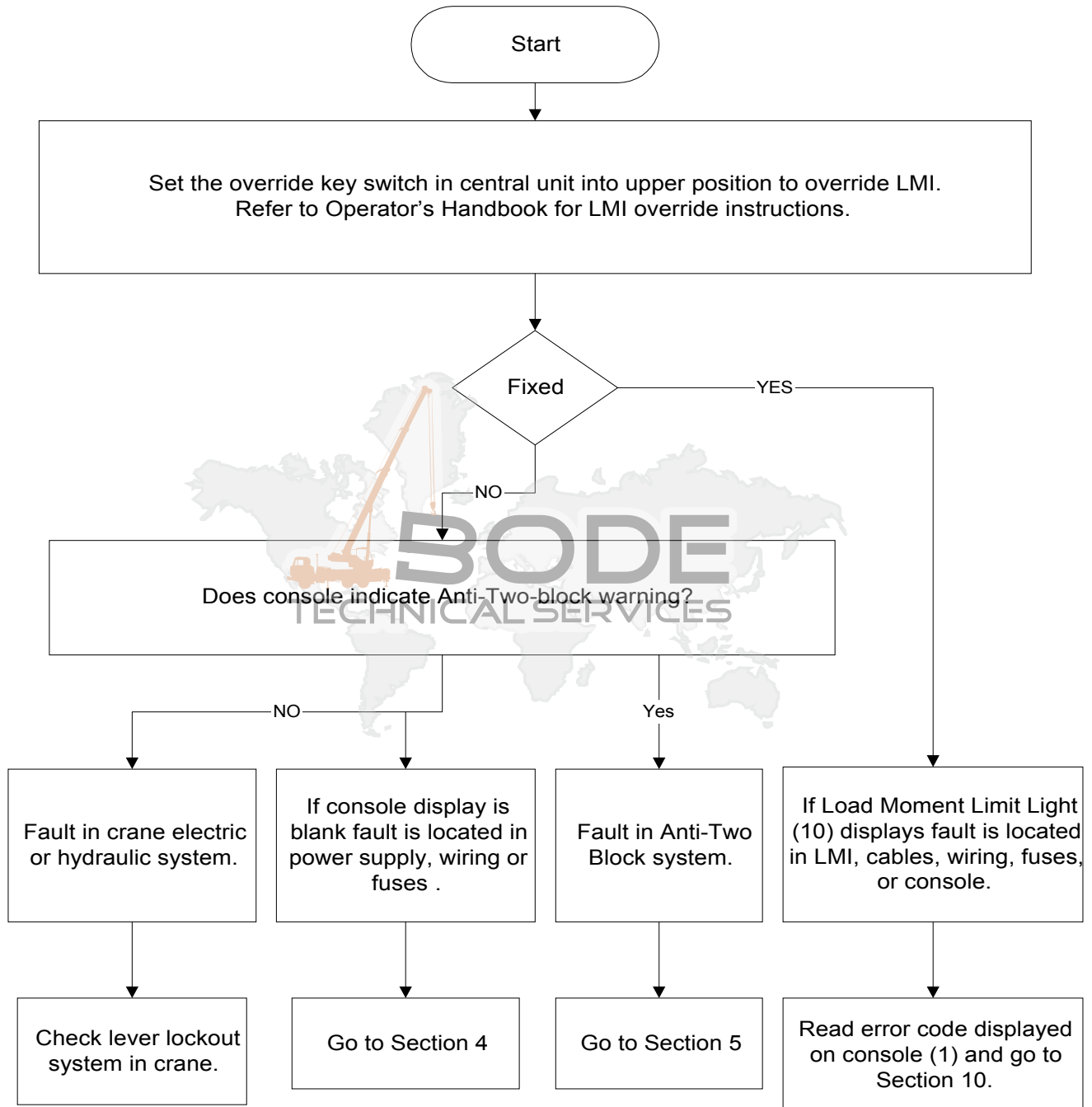

3. BROKEN LENGTH CABLE

PROBLEM: Damaged or broken length cable.

Replace length cable using the following procedure:

- 1 Cut old cable at cable drum
- 2 Disconnect damaged length cable from junction box at the boom nose.
- 3 Open cable reel cover and disconnect wiring from connection block. Pull 7 conductor cable out of strain relief.
- 4 Remove cable reel from mounting brackets.
- 5 Remove damaged length cable, which is mounted to the slip rings in the cable reel, from slipping connection. Refer to Drawing 1 in Section 11 - Drawings
- 6 On the back side of the cable reel, open the strain relief attached to the axle in the center of the drum. Pull existing length cable out of the cable reel.
- 7 Pull new length cable through the hole, pipe and strain relief and push it through the axle of the reeling drum. Tighten strain relief to ensure sealing.
- 8 Reconnect the length cable to the slipping. Refer to Drawing 1 in Section 11 - Drawings.
- 9 Remount cable reel to the boom.
- 10 Turn reeling drum clockwise to spool the new cable neatly onto the drum.
- 11 Set preload on cable reel by turning the drum counter-clockwise 5 to 8 turns.
- 12 Wrap the new length cable around the boom tip anchor pin (4 or 5 wraps) and secure with tie wraps. Leave enough length cable to connect into the boom tip junction box.
- 13 Connect the length cable into the boom tip junction box. Refer to Drawing 1 in Section 11 - Drawings.
- 14 Reset length potentiometer in length angle transducer (screw is located in center of white gear); with boom fully retracted, turn potentiometer carefully counter-clockwise until it stops. Recheck length and angle display. Refer to Drawing 6 in Section 11 - Drawings.

4. NO DISPLAY

PROBLEM: Blank console display with no warning light shown. All crane moments have been stopped.

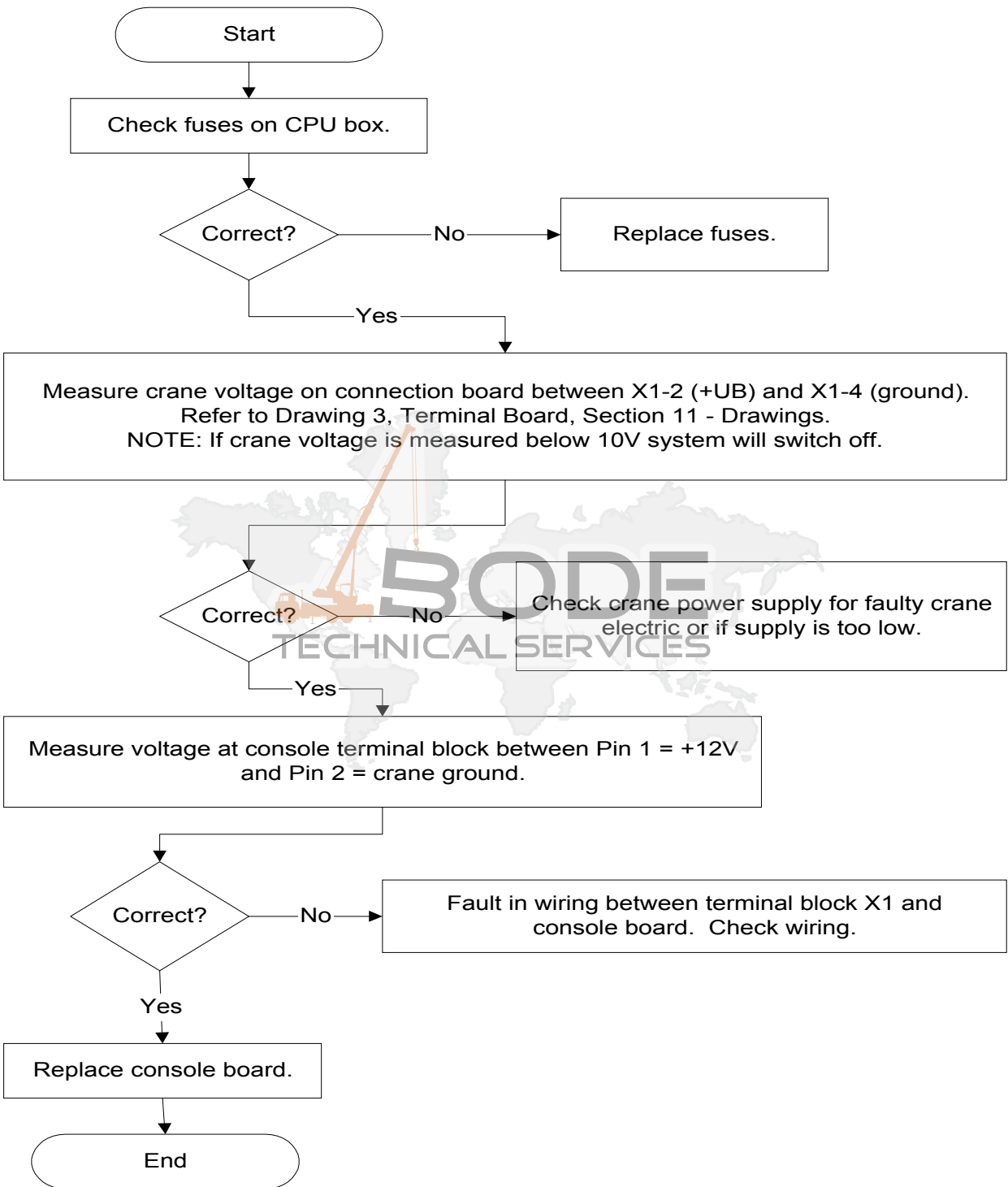

4. NO DISPLAY -continued

Continued from previous page

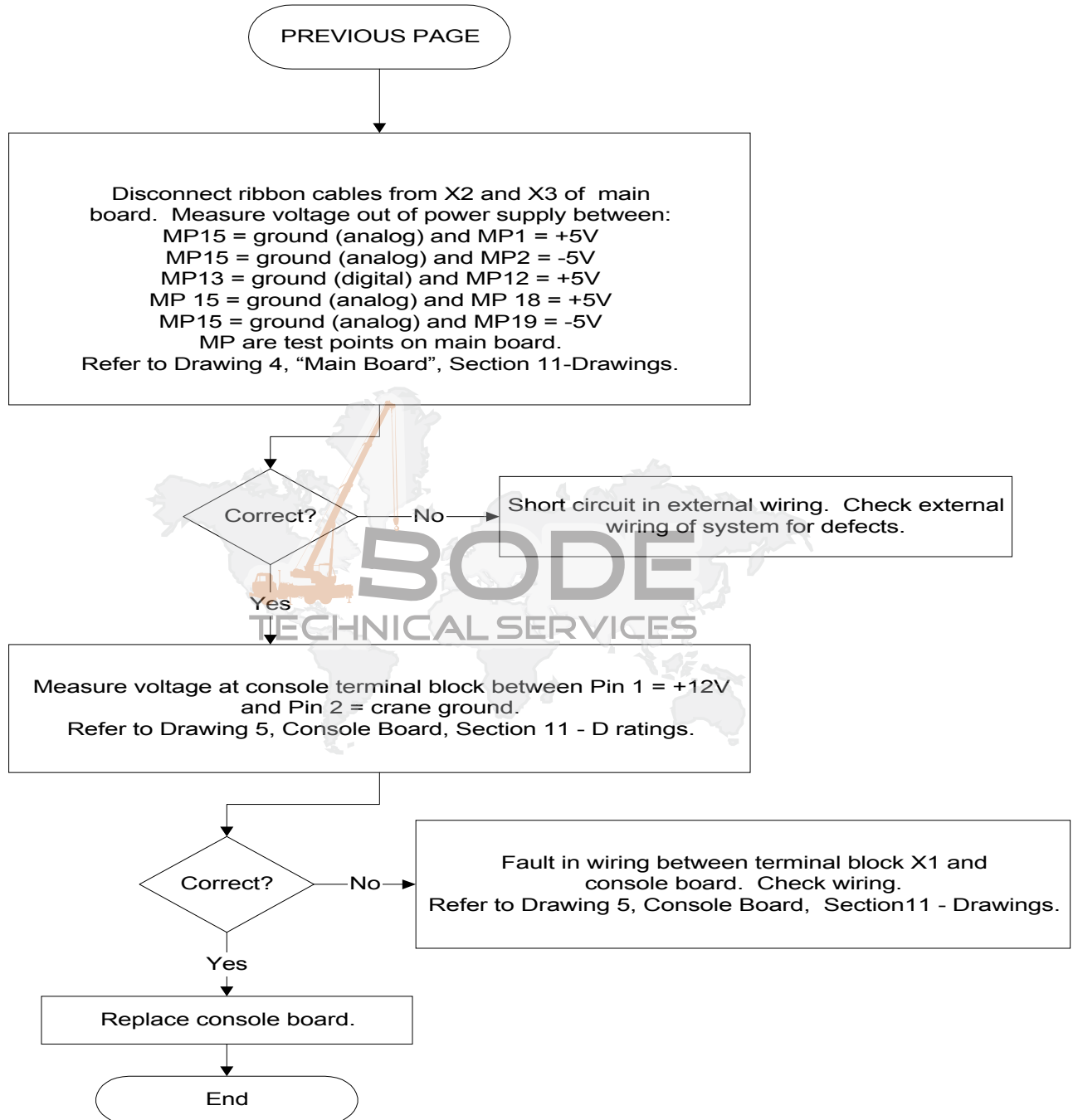

5. ANTI TWO BLOCK PROBLEM

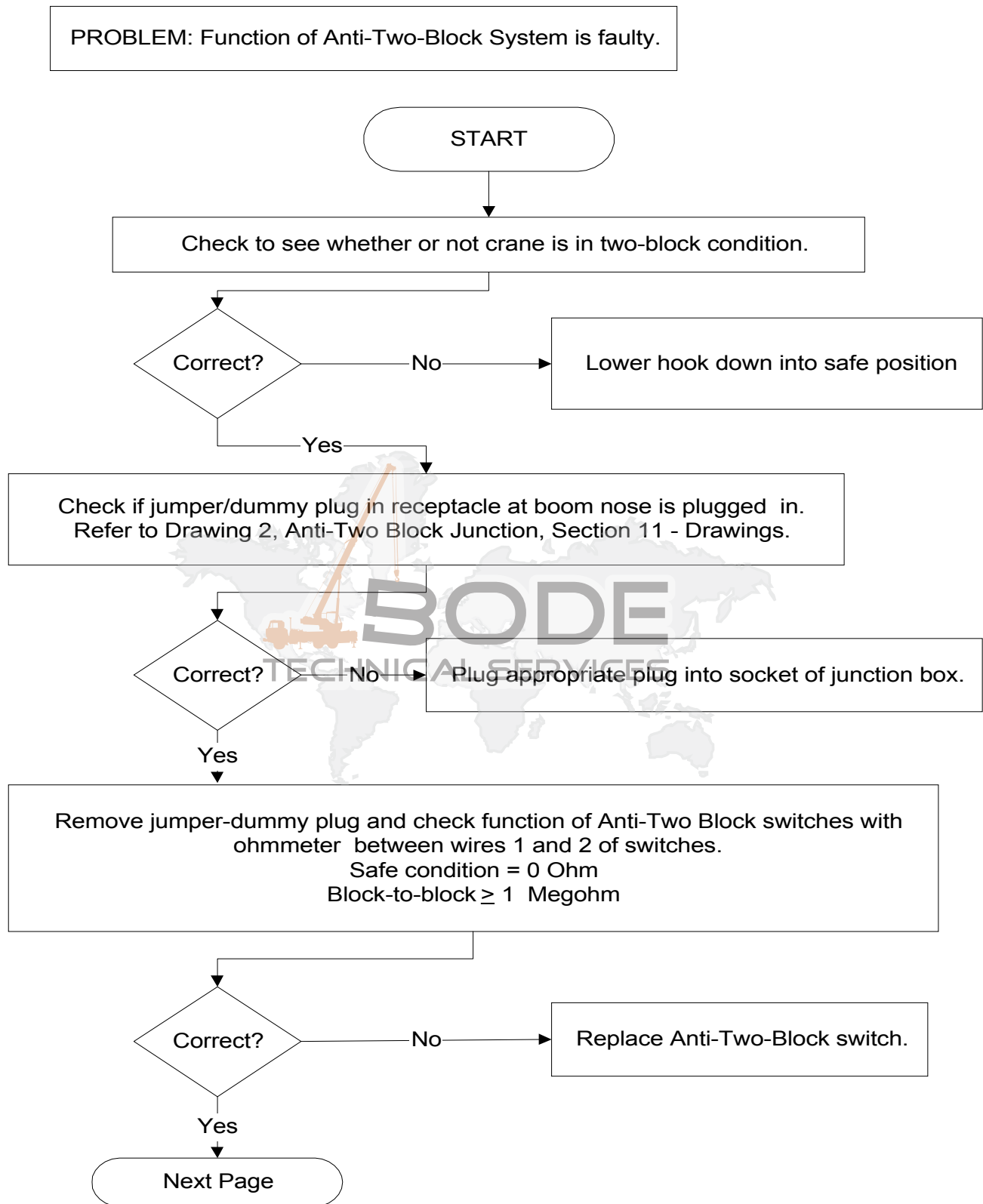

5. ANTI TWO BLOCK PROBLEM - continued

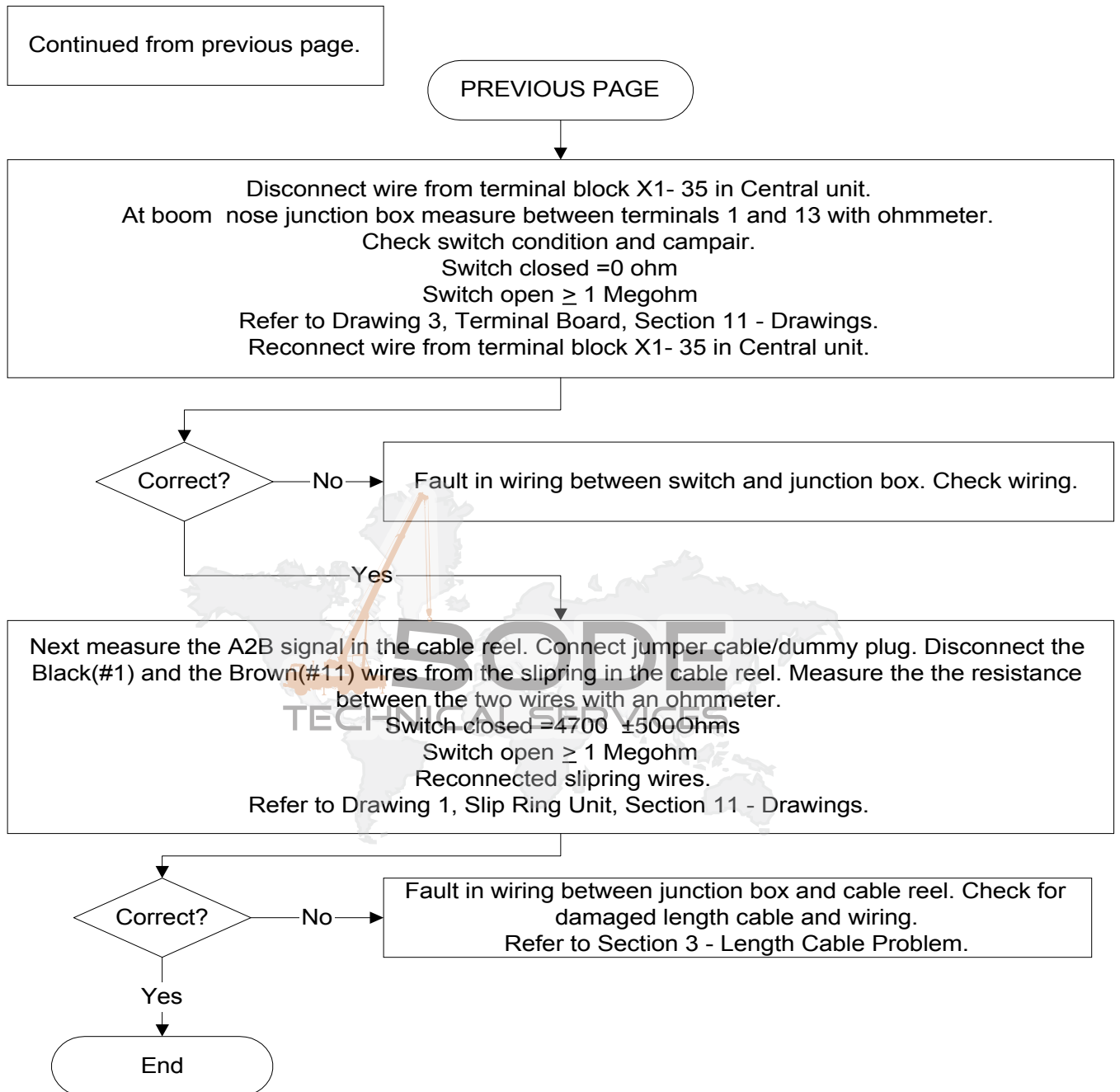

5. ANTI TWO BLOCK PROBLEM - continued

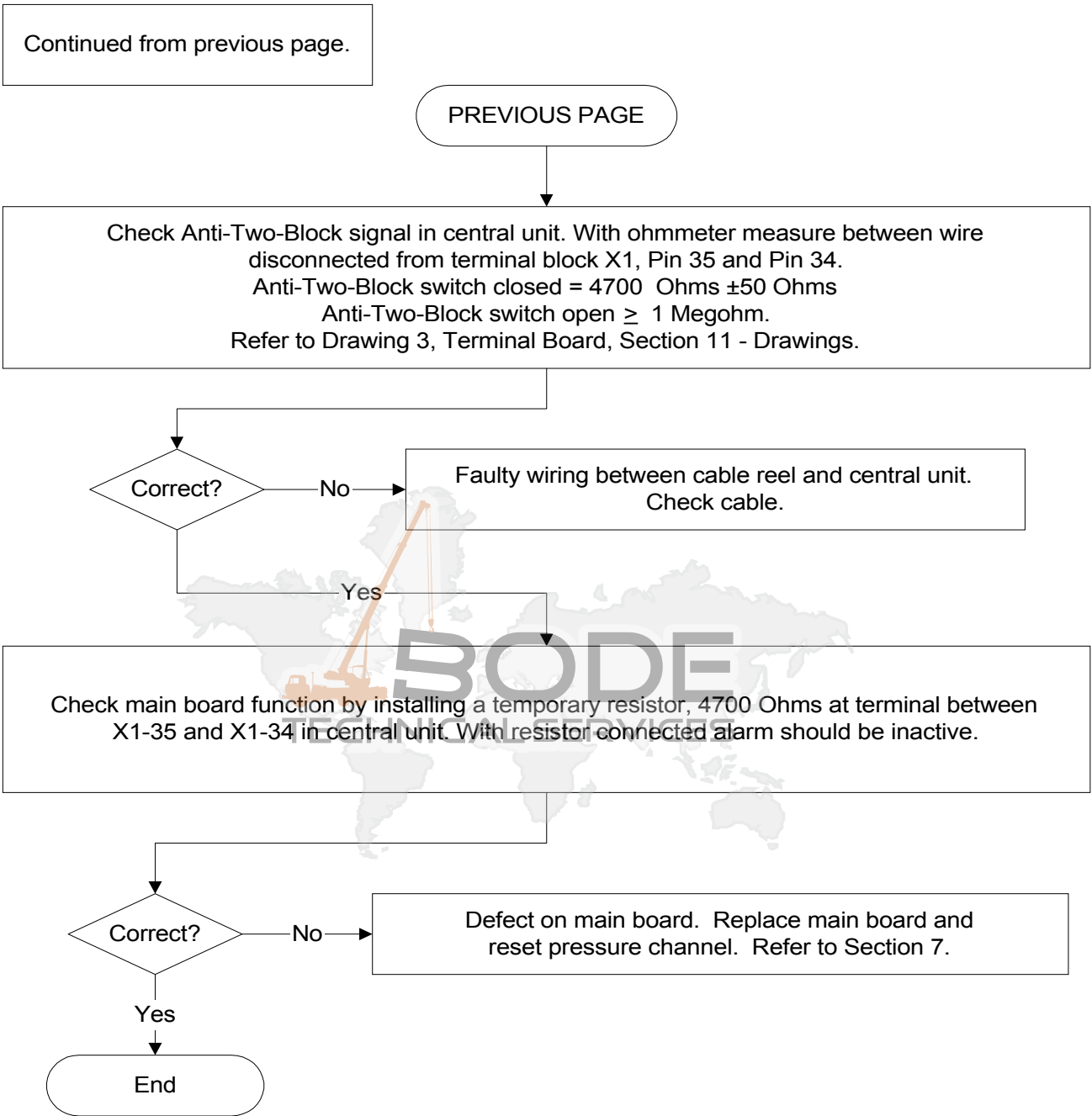

6. LENGTH READING PROBLEM

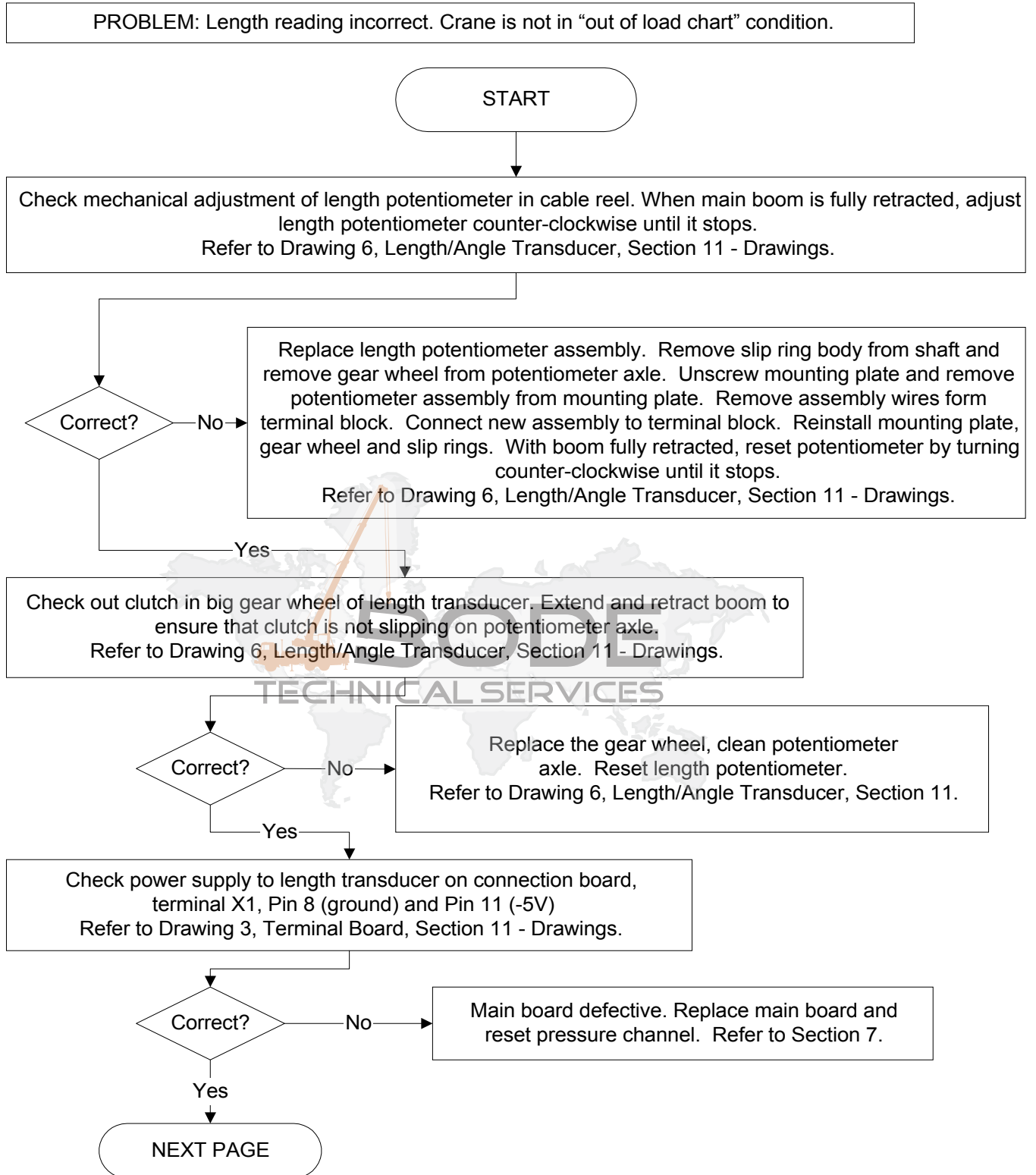

6. LENGTH READING PROBLEM - continued

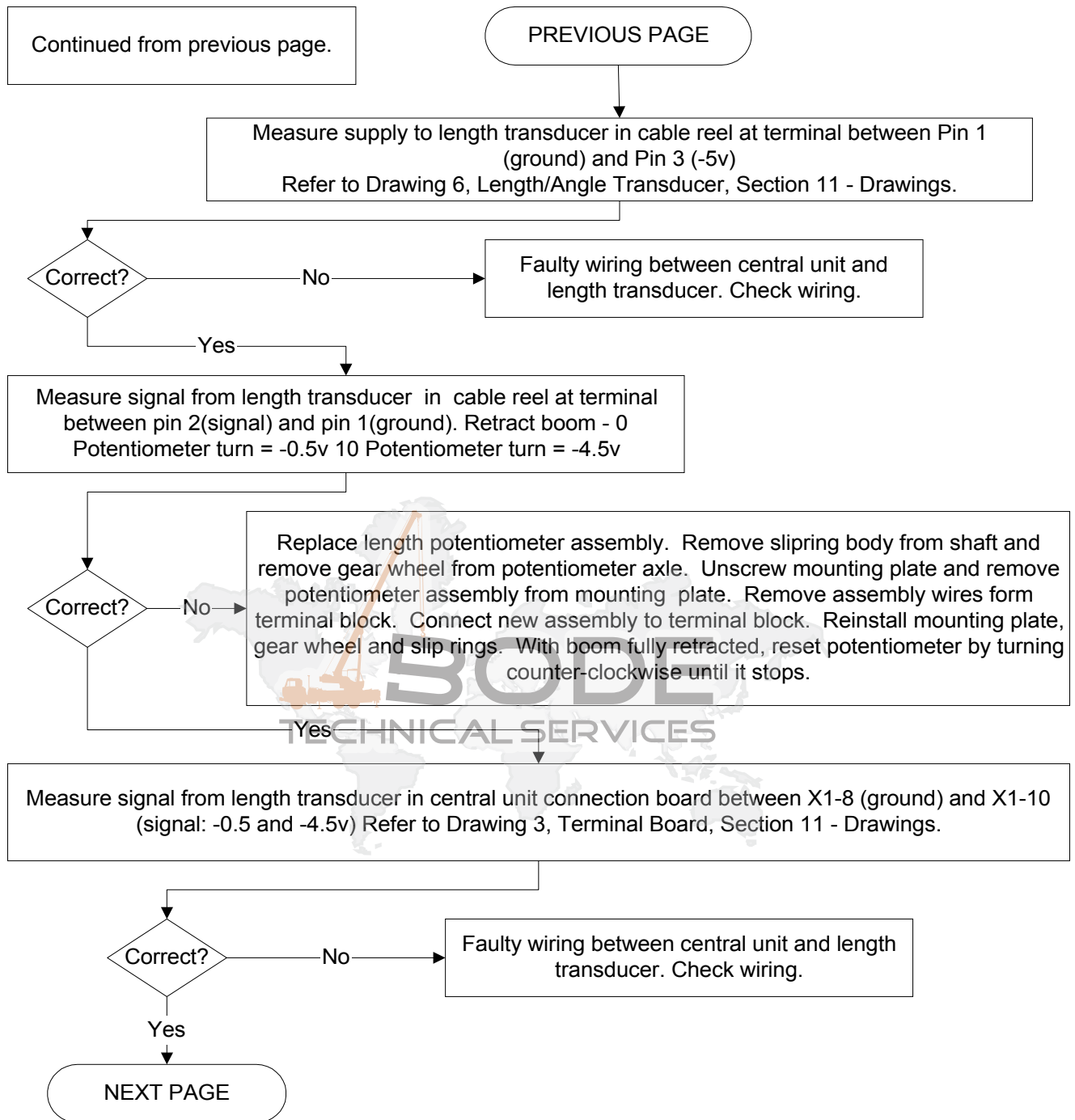

6. LENGTH READING PROBLEM - continued

Continued from previous page.

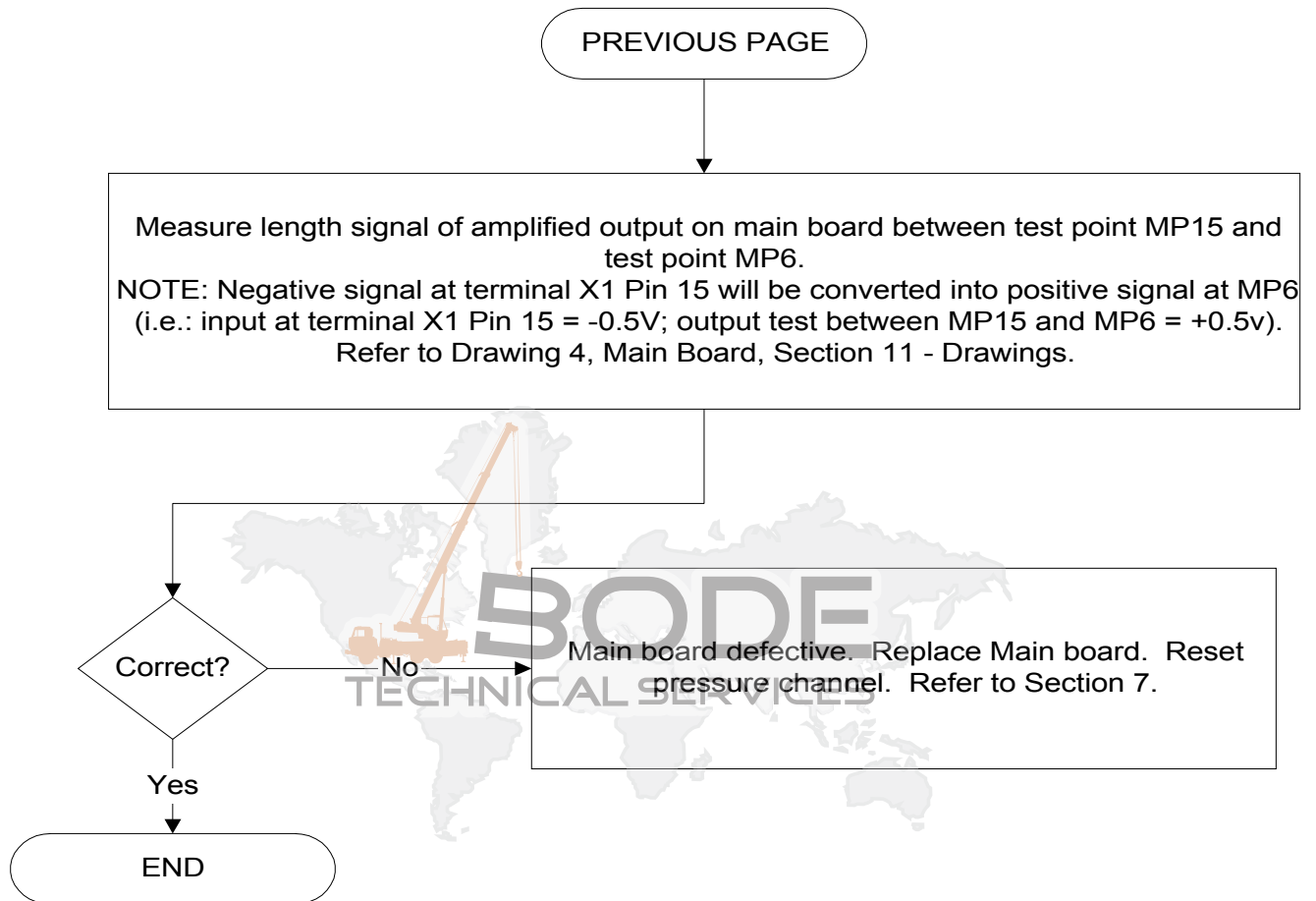

7. LOAD READING PROBLEM

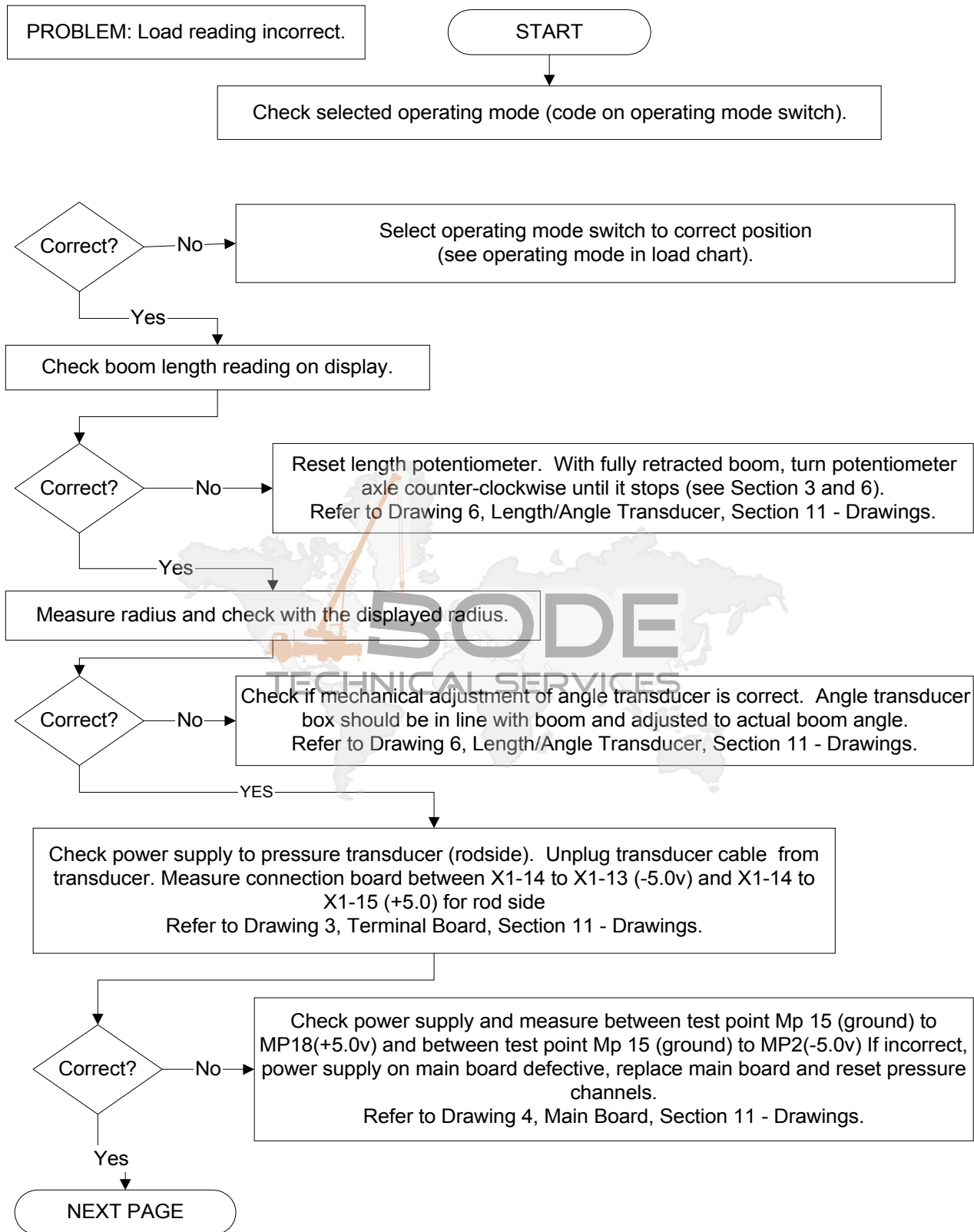

7. LOAD READING PROBLEM - continued

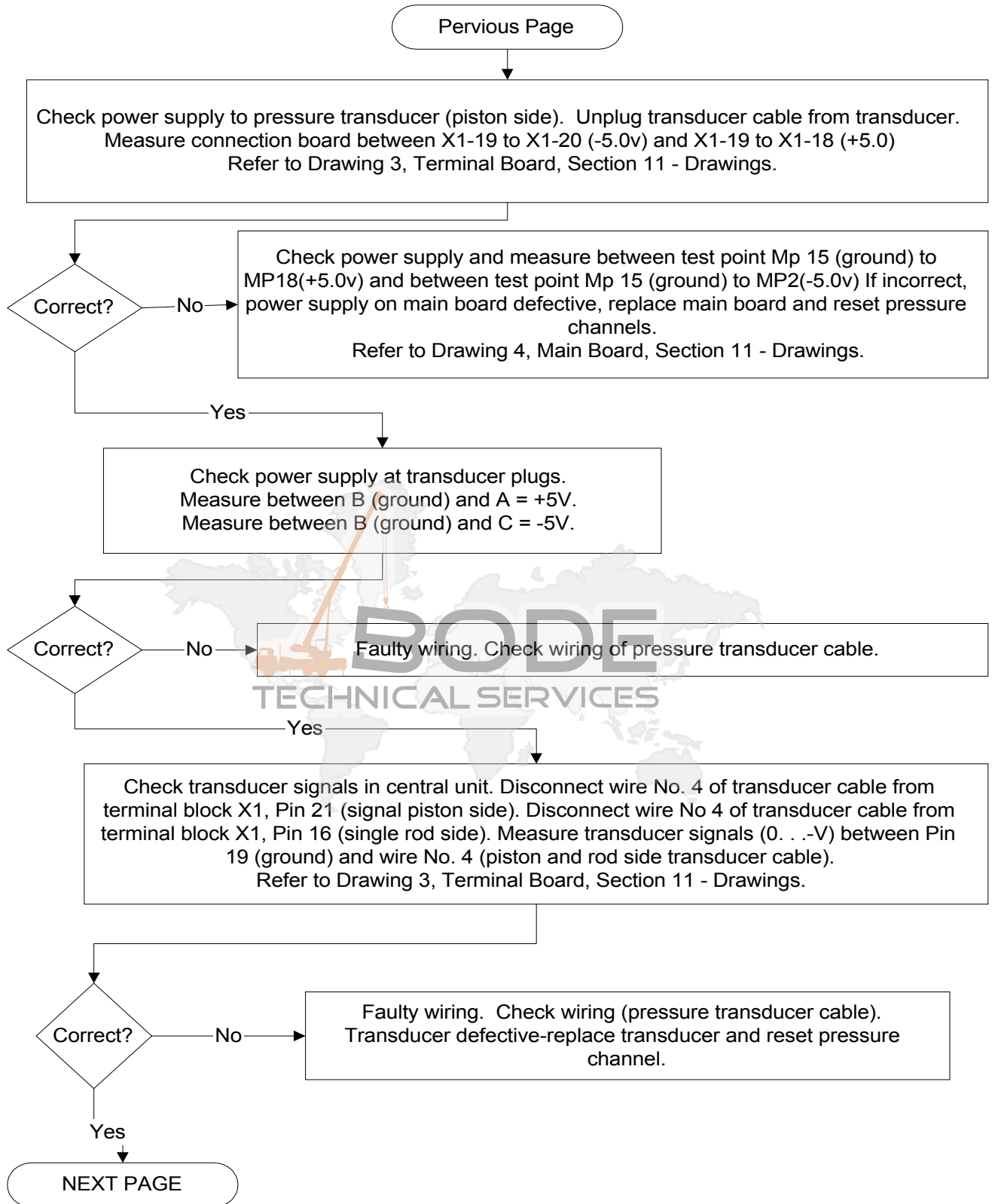

7. LOAD READING PROBLEM - continued

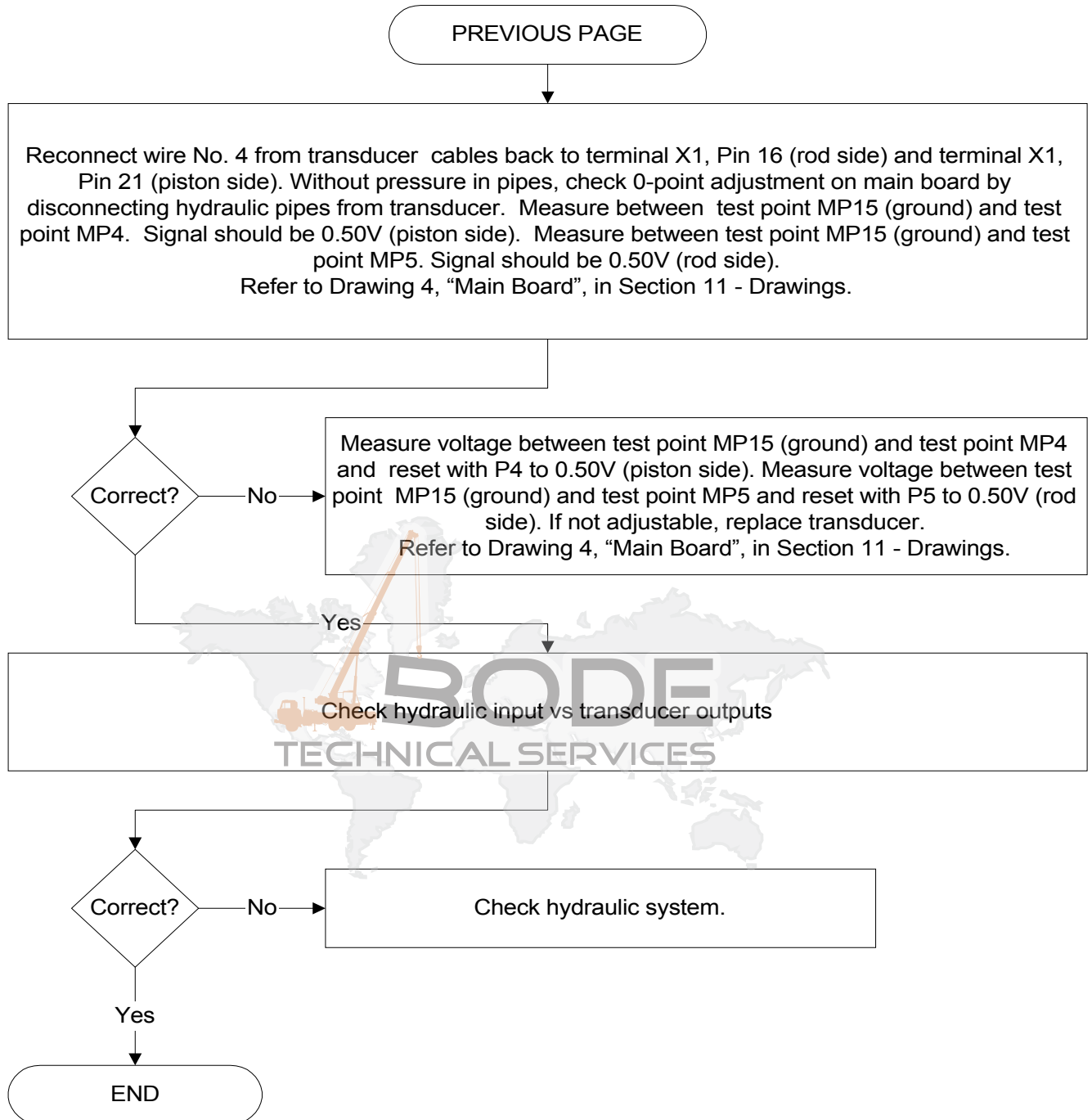

8 BAD DATA TRANSFER BETWEEN CONSOLE & CENTRAL UNIT

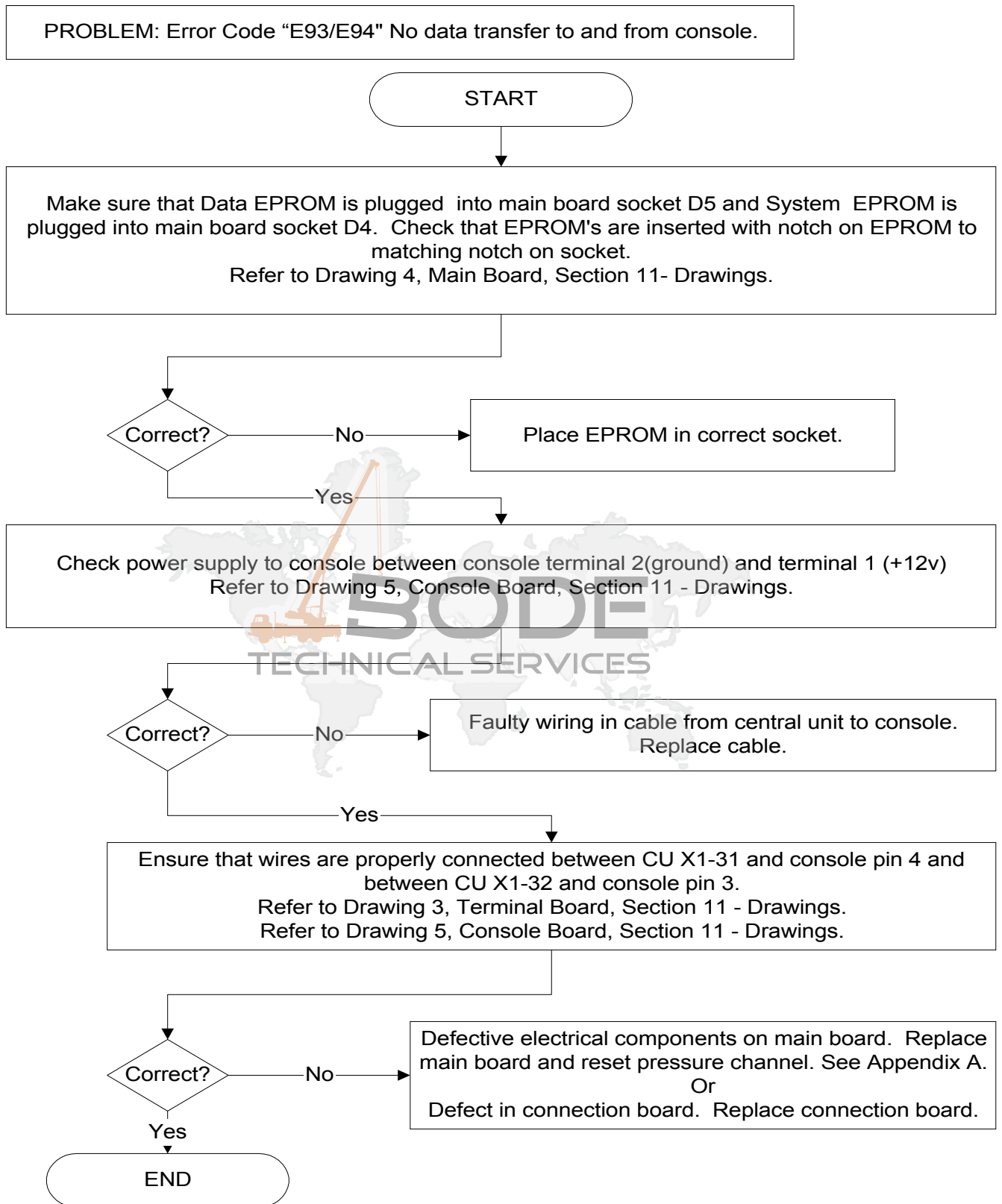

8 BAD DATA TRANSFER BETWEEN CONSOLE & CU - continued

Continued from previous page

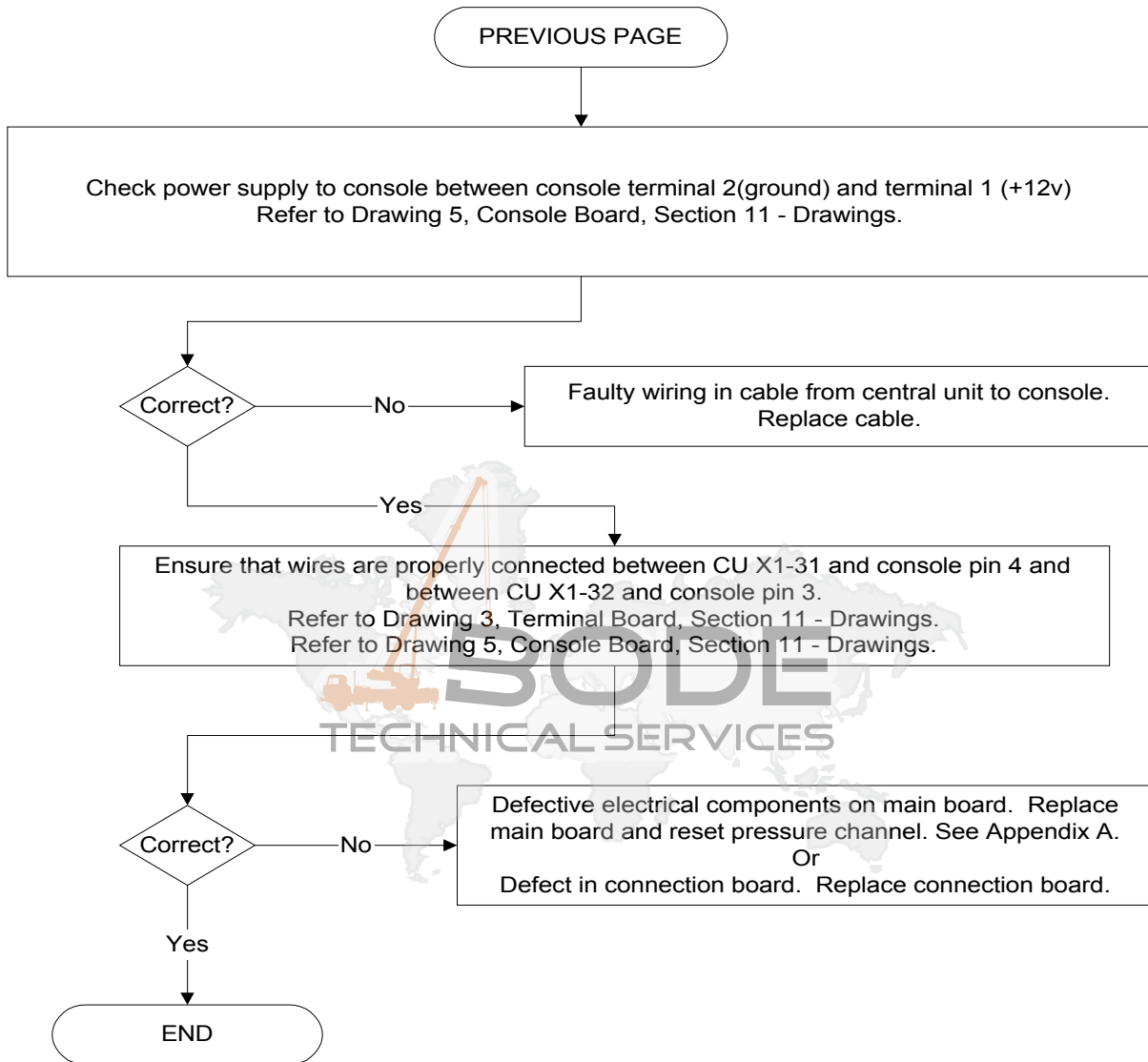

9. INTERFERENCE PROBLEM

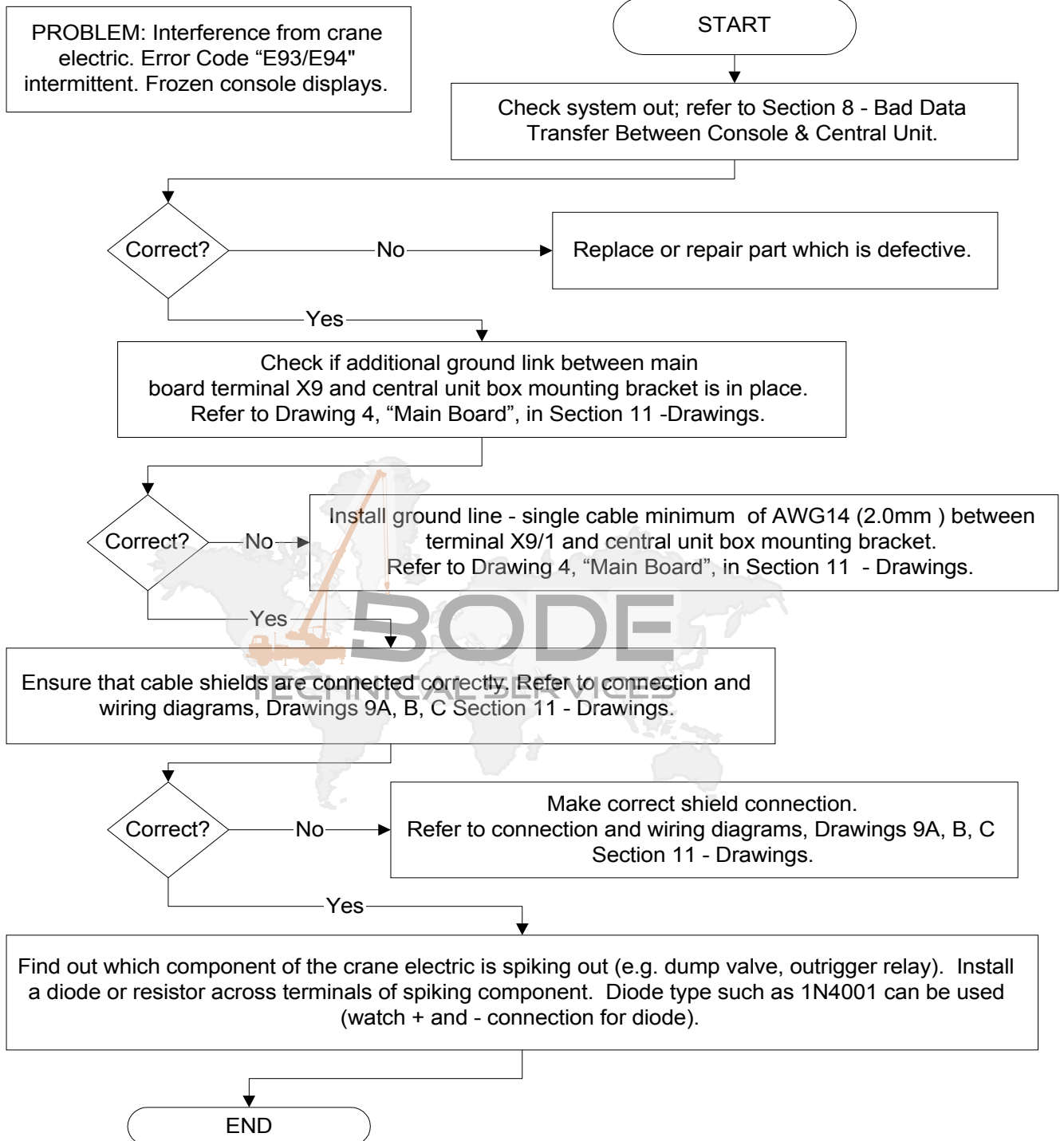

10. LIGHTBAR MALFUNCTION

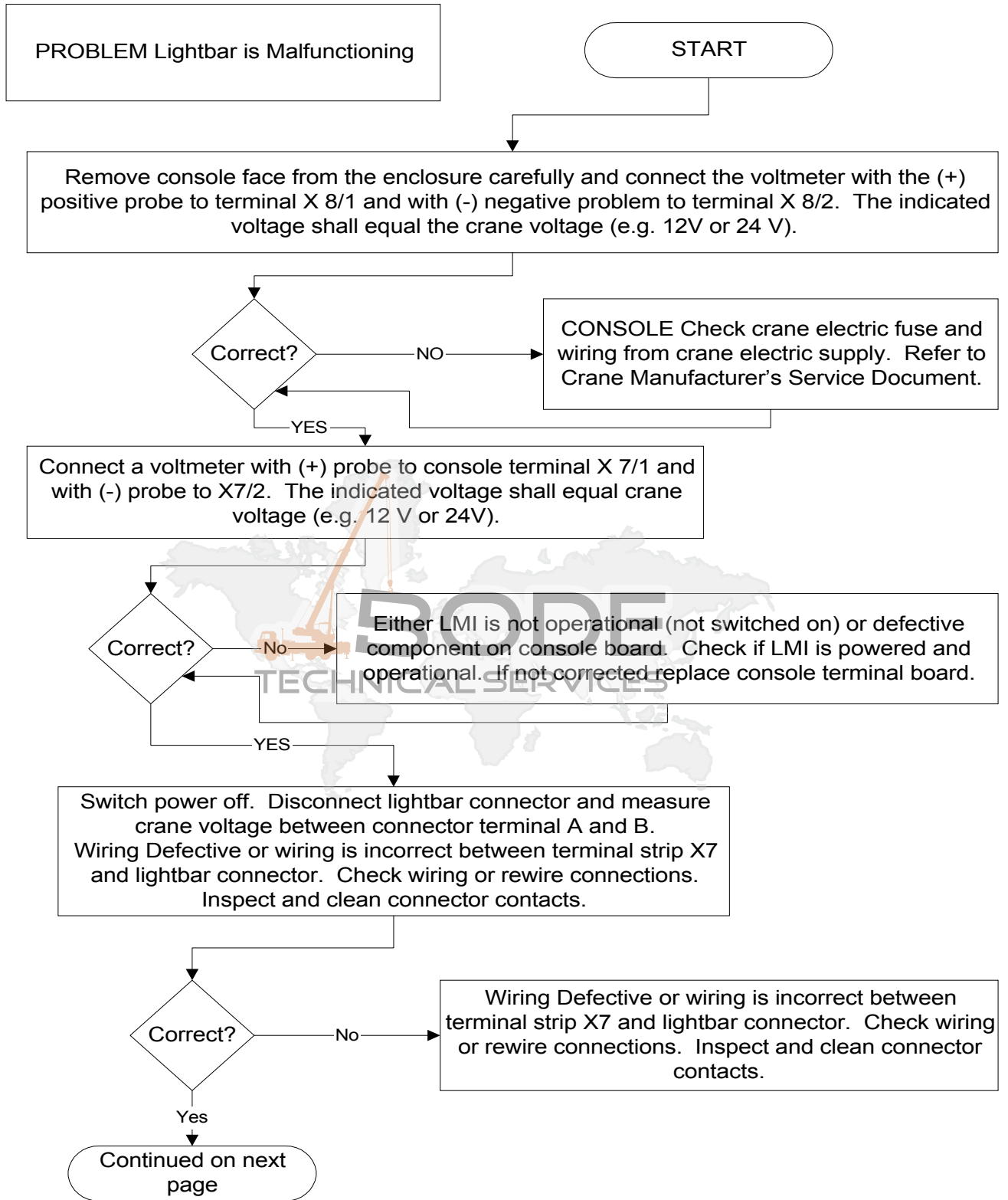

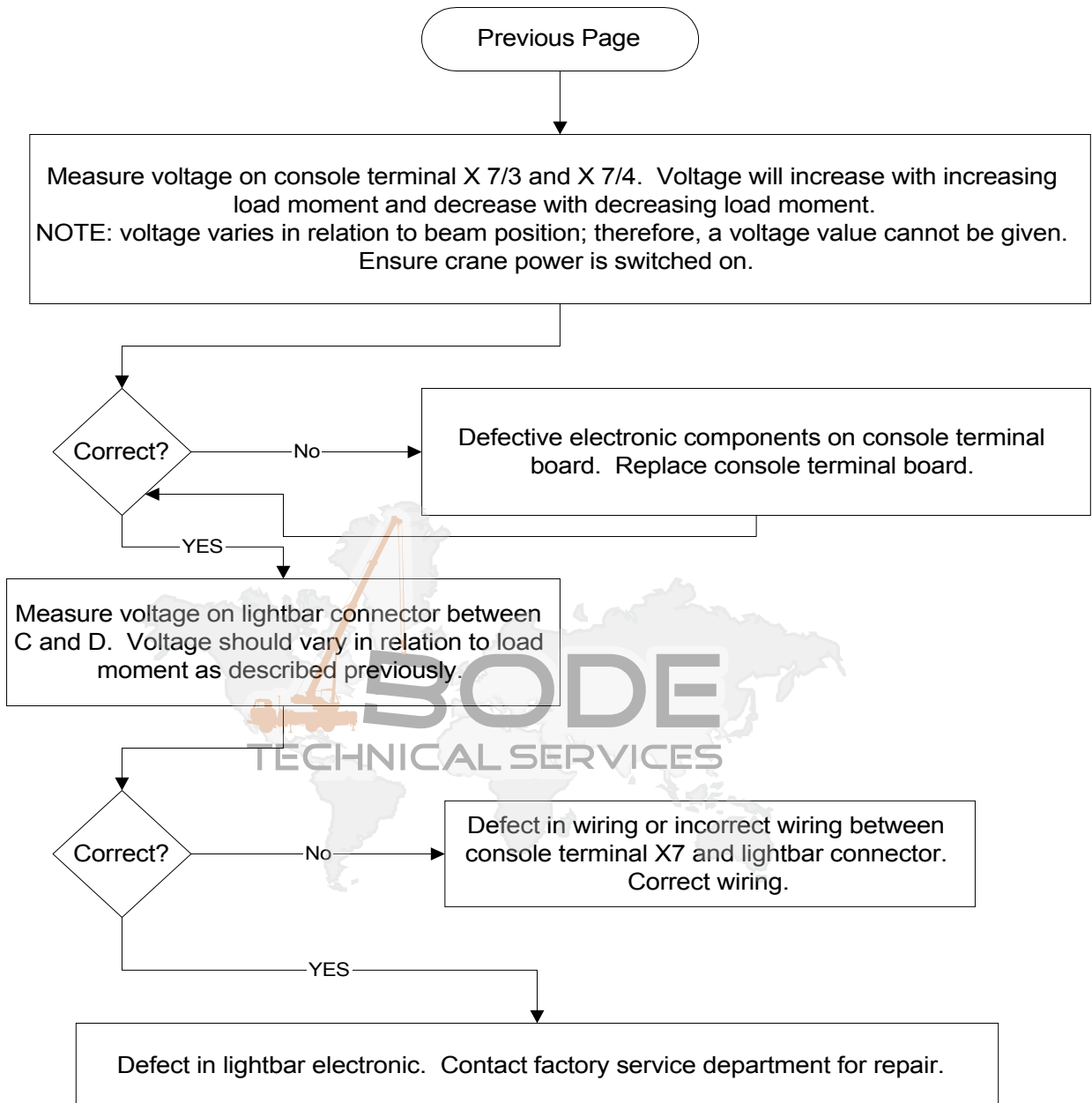
10. LIGHTBAR MALFUNCTION - continued

6. ERROR CODE DISPLAY

PROBLEM: Error code displayed. Lever lockout activated. Warning lights on.

ERROR CODE	ERROR	CAUSE	ACTION
E01	Minimum radius or maximum angle range exceeded	Fallen below the minimum radius or above the angle given in the load chart due to raising the boom to far.	Lower boom back to a radius or angle given in the load chart.
E02	Maximum radius or minimum angle range exceeded	The maximum radius or minimum angle given in the load chart was exceeded due to lowering the boom too far.	Raise boom back to a radius or angle given in the load chart.
E03	Prohibited slewing range (no load area)	Slewing range prohibited with load.	Slew back into admissible range.
E04	Operating mode not available	Operating mode switch in the console set incorrectly. Operating mode is not permissible with actual crane configuration.	Set operating mode switch correctly to the code assigned to the operating mode of the crane.
E05	Length range not permitted	Boom has been extended too far or not far enough. Length sensor adjustment changed; i.e. length sensor cable slid off the cable drum.	Retract or extend boom to correct length given in the load chart.
E06	Fallen below angle range with luffing jib operation.	Fallen below the minimum jib angle specified in the respective load chart due to luffing out the jib too far.	Luff in the jib to a radius or angle specified in the load chart.
E07	No acknowledgment signal from overload relay (K1).	Overload relay is stuck, defective or not being selected.	Replace relay.
E08	No acknowledgment signal from Anti-Two-Block switch relay (K2).	Anti-Two-Block switch relay is defective or not being selected.	Replace relay.
E11	Fallen below limit for the measuring channel "length".	a.) Cable between length sensor and central unit defective not connected or water in the connectors. b.) Length sensor Potentiometer defective. c.) Electronic board in the measuring channel defective.	a.) Check cable and connector as well and replace, if necessary. Section 6. b.) Replace and reset length sensor Potentiometer. See Section 6. c.) Replace main board and reset pressure channels.

ERROR CODE	ERROR	CAUSE	ACTION
E12	Fallen below lower limit value for the measuring channel "pressure transducer piston side".	a.) Cable leading from the central unit to the pressure transducer defective, loose or water in the connector. b.) Pressure transducer on piston side defective. c.) Electronic component in the measuring channel defective.	a.) Check cable and connector as well and replace, if necessary. b.) Replace pressure transducer and reset pressure channel.. c.) Replace main board and reset pressure channels.
E13	Fallen below lower limit value for the measuring channel "pressure transducer rod side".	a.) Cable leading from the central unit to the pressure transducer defective, loose or water in the connector. b.) Pressure transducer on rod side defective. c.) Electronic component in the measuring channel defective.	a.) Check cable and connectors as well and replace, if necessary. b.) Replace pressure transducer and reset pressure channel. c.) Replace main board and reset pressure channels..
E14	Fallen below lower limit value for the measuring channel "force".	a.) Cable leading from the central unit to the pressure transducer defective, loose or water in the connector. b.) Force transducer defective. c.) Electronic component in the measuring channel defective.	a.) Check cable and connectors as well and replace, if necessary. b.) Replace force transducer. c.) Replace main board and reset pressure channels.
E15	Fallen below lower limit value for the measuring channel "angle main boom".	a.) Cable from central unit to the length/angle sensor defective or loose. b.) Angle sensor defective. c.) Electronic component in the measuring channel defective.	a.) Check cable. Replace if necessary. See Section 6 b.) Replace angle sensor and reset adjustment. c.) Replace main board and reset pressure channels. .
E16	Fallen below lower limit value for measuring channel "Luffing Jib Angle".	a.) Cable from central unit to angle sensor defective or disconnected or water inside the plug. b.) Angle sensor defective. c.) Electronic component in the measuring channel defective.	a.) Check cable as well as plug, replace if need be. b.) Replace angle sensor. c.) Replace Main board and reset pressure channels.

ERROR CODE	ERROR	CAUSE	ACTION
E17	Fallen below lower limit value for the measuring channel 7.	a.)Cable leading from the central unit to the sensor of channel 7 defective, loose or water in the connectors. b.)Sensor of channel 7 defective. c.)Electronic component in the measuring channel 7 defective.	a.)Check cable as well as connectors and replace, if necessary. b.)Replace sensor of channel 7 and reset adjustment. c.)Replace main board and reset pressure channels.
E19	Error in the reference voltage.	Electronic component on the main board defective.	Replace main board and reset pressure channels.
E20	No analog voltages	a.)The crane supply voltage is too low. b.)The voltage converter is defective or short circuit in the wiring.	a.)Check crane voltage. b.)Check supply voltages.
E21	Upper limiting value for the measuring channel "length" exceeded.	a.)Cable from central unit to the length/angle sensor defective or loose. b.)Length potentiometer defective. c.)Electronic component in the measuring channel defective on main board.	a.)Check cable. Replace if necessary. See Section 6. b.)Replace and reset length potentiometer. c.)Replace main board and reset pressure channels.
E22	Upper limiting value for the measuring channel "pressure piston side" exceeded.	a.)Cable from central unit to the pressure transducer defective, loose or water in the plug. b.)Pressure transducer on piston side defective. c.)Electronic component in the measuring channel defective on main board.	a.)Check cable as well as plug. Replace if necessary. b.)Replace pressure transducer and reset pressure channels. c.)Replace main board and reset pressure channels.
E23	Upper limit value for the measuring channel "pressure transducer rod side" exceeded.	a.) Cable from the central unit to press trans defective, not connected or water in the connectors. b.) Pressure transducer on rod side defective. c.) Electronic component in the measuring channel defective.	a.) Check cable and connectors as well and replace, if necessary. b.) Replace pressure transducer c.) Replace main board and reset pressure channels.

ERROR CODE	ERROR	CAUSE	ACTION
E24	Upper limit value for the measuring channel "force" exceeded.	a.) Cable leading from the central unit to the force transducer defective, not connected or water in the connectors. b.) Force transducer defective. c.) Electric component in the measuring channel defective.	a.) Check cable and connectors as well and replace, if necessary. b.) Replace force transducer. c.) Replace main board and reset pressure channels.
E25	Upper limit value for the measuring channel "angle main boom" exceeded.	a.) Cable leading from the central unit to the length/angle sensor defective, loose or water in the connectors. b.) Angle sensor defective c.) Electronic component in the measuring channel defective.	a.) Check cable as well as connectors and replace, if necessary. Section No. 6. b.) Replace angle sensor and reset adjustment. c.) Replace main board and reset pressure channels.
E26	Upper limit value for the measuring channel "Luffing Jib Angle" exceeded.	a.) Cable leading from the central unit to the jib angle sensor defective, loose or water in the connectors. b.) Jib angle sensor defective. c.) Electronic component in the measuring channel defective.	a.) Check cable as well as connectors and replace, if necessary. b.) Replace jib angle sensor and reset adjustment. c.) Replace main board and reset pressure channels.
E27	Upper limit value for the measuring channel 7 exceeded.	a.) Cable leading from the central unit to the sensor of channel 7 defective, loose or water in the connectors. b.) Sensor of channel 7 defective. c.) Electronic component in the measuring channel 7 defective.	a.) Check cable as well as connectors and replace, if necessary. b.) Replace sensor of channel 7 and reset adjustment. c.) Replace main board and reset pressure channels.
E29	Reference voltage defective.	a.) The total of the supply and the reference voltages on MP10 is more than 3.3V b.) A/D converter defective.	a.) Check supply voltages. b.) Replace main board and reset pressure channels.

ERROR CODE	ERROR	CAUSE	ACTION
E31	Error in the system program.	a.) EPROM with system program defective. b.) Electronic component on the main board defective.	a.) Replace system program EPROM b.) Replace main board and reset pressure channels.
E37	Error in the program run	a.) EPROM with system program defective. b.) Electronic component on the main board defective.	a.) Replace system program EPROM. b.) Replace main board and reset pressure channels. .
E38	Wrong system program in the LMI.	The system program in the LMI does not correspond to the programming in the data EPROM	Replace system program EPROM
E 41	Error in the external RAM.		Replace main board and reset pressure channels. Section7
E 42	Error in the external write/read memory (RAM).	Internal defect in digital part of CPU.	Exchange write/read memory (CMOS-RAM). Replace main board and reset pressure channels. See Section 7.
E 45	Error in internal communications.	Defective electronic component.	Replace main board and reset pressure channels. Section 7.
E 48	Malfunction in the monitored write/read memory.	Internal defect in digital part of CPU	Replace main board and reset pressure channels.
E 51	Error in data memory.	Data EPROM on the main board defective.	Replace Data EPROM. Make sure BR3 on the main board is installed.
E71	Incorrect acknowledgment of the 1. Relay on the terminal board A101.	a.) Anti Two-block relay is stuck or defective. b.) Anti Two-Block relay is not being selected due to a break on the terminal board A101, main board or ribbon cables.	a.) Replace 1. relay. b.) Check terminal board A101, main board and ribbon cables as well as replace defective part, if necessary.
E72 - E77	Analogous to E71 for the relays 2...7.	Analogous to E71 for the relays 2...7.	Analogous to E71 for the relays 2..7.

ERROR CODE	ERROR	CAUSE	ACTION
E89	Change of the operating code during lifting a load.	The operating mode switch in the console was used during lifting a load.	Lower the load and set the operating mode switch correctly to the code assigned to the actual operating mode of the crane.
E 91	No data transmission from console to central unit. (See Section 8 and 9)	a.) This causes no display. b.) Interruption or accidental ground in the line from console electronics to central unit. c.) Transmitter/receiver module defective.	a.) Check the connection between console electronics and central unit. b.) If you find an accidental ground, the transmitter module in the console electronics can be damaged. You should, therefore, replace the console electronics. Replace console electronics or main board respectively.
E92	Error in the data transmission from console to central unit. (See also Section 8 and 9)	a.) Temporary interruption of the data line from console electronics to central unit. b.) Transmitter/receiver module defective.	a.) Check the connection between console electronics and central unit.
E93	Error in the data transmission from central unit to console. (See also Section 8 and 9)	a.) Temporary interruption of the data line from console electronics to central unit. b.) Transmitter/receiver module defective.	a.) Check the connection between console electronics and central unit. b.) Replace console electronics or main board respectively.

ERROR CODE	ERROR	CAUSE	ACTION
E94	No data transmission from central unit to console.	<ul style="list-style-type: none"> a.) Interruption or accidental ground in the line from console electronics to central unit. b.) Transmitter/receiver module defective. c.) Data-EPROM defective. d.) CPU defective. e.) Electromagnetic interference (when switching contractors or valves) 	<ul style="list-style-type: none"> a.) Check the connection between console electronics and central unit. If you find an accidental ground, the transmitter module in the console electronics can be damaged. Replace the console electronics. b.) Replace console electronics or main board respectively. c.) Check data EPROM. d.) Replace main board. e.) Eliminate interference source by inverse diodes or varistors.
E95	Error in the crane data EPROM	<ul style="list-style-type: none"> a.) Data EPROM defective b.) Position of jumper for the selection of the type of EPROM is wrong c.) Electronics component on the main board defective. 	<ul style="list-style-type: none"> a.) Replace data EPROM b.) Check the jumper position c.) Replace main board and reset pressure channels.
E96	Error in the internal RAM of the CPU of the console	CPU or main board of the console defective	Replace console main board & Appendix A.
E97	Error in the external RAM of the CPU of the console	<ul style="list-style-type: none"> a.) External RAM of the console defective b.) Electronic component on the main board defective. 	<ul style="list-style-type: none"> a.) Replace console main board b.) Replace console main board
E98	Wrong jumper position in the console	<ul style="list-style-type: none"> a.) The jumper position BR 9/BR 10 in the console does not correspond to the actual type of central unit. b.) Electronic component on the main board defective. 	<ul style="list-style-type: none"> a.) Check the jumper position b.) Replace console main board.

REFERENCE GUIDE

Use the table as a quick reference for measuring supply and signal voltages for the sensor channels that are specific to the error code listed.

Signal Voltage					
Error Code	Channel		Terminal Board Terminal X1		Nominal Voltage (VDC)
			Pin 'ground'	Pin 'supply'	
E11/21	1	Length	8	11	-5
E12/22	2	Pressure Piston side	19	20	-5
			19	18	+5
E13/23	3	Pressure Rod side	14	15	-5
			14	13	+5
E14/24	4	Force	27	26	+18
E15/25	5	Angle Main boom	8	11	-5
E16/26	6	Angle Jib	23	25	-5
E17/27	7				

Signal Voltage						
Error Code	Channel		Terminal Board Terminal X1			Amplified Signal on main board use MP15 - GND and MP supply voltage 0.5...4.5V
			Pin 'ground'	Pin 'supply'	Voltage (VDC)	
E11/21	1	Length	8	10	-0.5...-4.5	MP6
E12/22	2	Pressure Piston side	8	21	0...-1	MP4
E13/23	3	Pressure Rod side	8	16	0...-1	MP5
E14/24	4	Force	29	28	0...-1	MP3
E15/25	5	Angle Main boom	8	9	-1.875...-3.125	MP8
E16/26	6	Angle Jib	8	24	-1.875...-3.125	MP9
E17/27	7		8	7	-0.5...-4.5	MP7